

# JVC

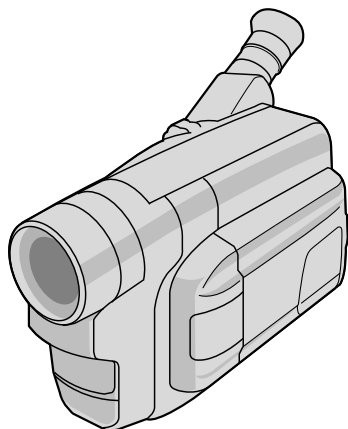

## COMPACT VHS CAMCORDER

# GR-FXM16



## INSTRUCTIONS

### CONTENTS

<b>GETTING STARTED</b>	<b>6 - 13</b>
Power .....	6
Clock (Lithium) Battery Insertion/Removal ...	8
Date/Time Settings .....	9
Recording Mode Setting .....	10
Tape Length Setting .....	10
Loading/Unloading A Cassette .....	11
Grip Adjustment .....	12
Viewfinder Adjustment .....	12
Shoulder Strap Attachment .....	13
Tripod Mounting .....	13
<b>RECORDING</b>	<b>14 - 35</b>
Basic Recording .....	14
Basic Features .....	18
Advanced Features .....	21
<b>PLAYBACK</b>	<b>36 - 41</b>
Basic Playback .....	36
Features .....	37
Using The Cassette Adapter (optional) .....	39
Basic Connections And Tape Dubbing .....	40
<b>USING THE REMOTE CONTROL UNIT (optional)</b>	<b>42 - 49</b>
Random Assemble Editing .....	44
Insert Editing .....	48
Audio Dubbing .....	49
<b>USER MAINTENANCE</b>	<b>50</b>
<b>TROUBLESHOOTING</b>	<b>51 - 52</b>
<b>INDEX</b>	<b>53 - 56</b>
Indications .....	53
Controls, Connectors And Indicators .....	54
Terms .....	56
<b>CAUTIONS</b>	<b>57 - 58</b>
<b>SPECIFICATIONS</b>	<b>59</b>

**Dear Customer,**

Thank you for purchasing the JVC Compact VHS camcorder. Before use, please read the safety information and precautions contained in the following pages to ensure safe use of this product.

**Using This Instruction Manual**

- All major sections and subsections are listed in the Table Of Contents on the cover.
- Notes appear after most subsections. Be sure to read these as well.
- Basic and advanced features/operation are separated for easier reference.

**It is recommended that you . . .**

- .... refer to the Index (☞ pgs. 53 – 56) and familiarize yourself with button locations, etc. before use.
- .... read thoroughly the Safety Precautions. They contain extremely important information regarding the safe use of this product.

You are recommended to carefully read the cautions on pages 57 – 58 before use.

**WARNING:**

**TO PREVENT FIRE OR SHOCK HAZARD, DO NOT EXPOSE THIS UNIT TO RAIN OR MOISTURE.**

**Caution on Replaceable lithium battery**

The battery used in this device may present a fire or chemical burn hazard if mistreated. Do not recharge, disassemble, heat above 100°C or incinerate.

Replace battery with Panasonic (Matsushita Electric), Sanyo, Sony or Maxell CR2025. Danger of explosion or Risk of fire if the battery is incorrectly replaced.

- Dispose of used battery promptly.
- Keep away from children.
- Do not disassemble and do not dispose of in fire.

## SAFETY PRECAUTIONS

**IMPORTANT****Connection to the mains supply in the United Kingdom.**

**DO NOT cut off the mains plug from this equipment.** If the plug fitted is not suitable for the power points in your home or the cable is too short to reach a power point, then obtain an appropriate safety approved extension lead or consult your dealer.

**BE SURE to replace the fuse only with an identical approved type, as originally fitted, and to replace the fuse cover.**

If nonetheless the mains plug is cut off be sure to remove the fuse and dispose of the plug immediately, to avoid possible shock hazard by inadvertent connection to the mains supply.

If this product is not supplied fitted with a mains plug then follow the instructions given below:

**DO NOT** make any connection to the Larger Terminal coded E or Green.

The wires in the mains lead are coloured in accordance with the following code:

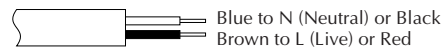

If these colours do not correspond with the terminal identifications of your plug, connect as follows:

Blue wire to terminal coded N (Neutral) or coloured black.

Brown wire to terminal coded L (Live) or coloured Red. If in doubt — consult a competent electrician.

**CAUTIONS:**

- To prevent shock, do not open the cabinet. No user serviceable parts inside. Refer servicing to qualified personnel.
- When you are not using the AC Power Adapter/Charger for a long period of time, it is recommended that you disconnect the power cord from AC outlet.

**NOTES:**

- *The rating plate (serial number plate) and safety caution are on the bottom and/or the back of the main unit.*
- *The rating information and safety caution of the AC Power Adapter/Charger are on its bottom.*

This camcorder is designed to be used with PAL-type colour television signals. It cannot be used for playback with a television of a different standard. However, live recording and LCD monitor/viewfinder playback are possible anywhere. Use the BN-V11U/V12U/V20U battery packs and, to recharge them, the provided multi-voltage AC Power Adapter/Charger. (An appropriate conversion adapter may be necessary to accommodate different designs of AC outlets in different countries.)

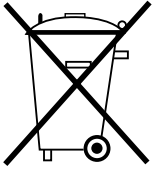
**Crossed Out Dust Bin Mark**

Cd

- The Crossed Out Dust Bin Mark on the battery pack indicates that the product complies with Directives 91/157/EEC and 93/86/EEC.
- Nickel-Cadmium (Ni-Cd) battery pack must be recycled or disposed of properly.



- This camcorder is designed exclusively for the VHS-C video cassette. Only cassettes marked VHS-C can be used with this unit.
- HQ VHS is compatible with existing VHS equipment.

When the equipment is installed in a cabinet or on a shelf, make sure that it has sufficient space on all sides to allow for ventilation (10 cm or more on both sides, on top and at the rear). Do not block the ventilation holes. (If the ventilation holes are blocked by a newspaper, or cloth etc. heat may not be able to get out.) No naked flame sources, such as lighted candles, should be placed on the apparatus. When discarding batteries, environmental problems must be considered and local rules or laws governing the disposal of these batteries must be followed strictly. The apparatus shall not be exposed to dripping or splashing. Do not use this equipment in a bathroom or places with water. Also do not place any containers filled with water or liquids (such as cosmetics or medicines, flower vases, potted plants, cups etc.) on top of this unit. (If water or liquid is allowed to enter this equipment, fire or electric shock may be caused.)

## SOME DO'S AND DON'TS ON THE SAFE USE OF EQUIPMENT

**This equipment has been designed and manufactured to meet international safety standards but, like any electrical equipment, care must be taken if you are to obtain the best results and safety is to be assured.**

- DO** read the operating instructions before you attempt to use the equipment.
- DO** ensure that all electrical connections (including the mains plug, extension leads and interconnections between pieces of equipment) are properly made and in accordance with the manufacturer's instructions. Switch off and withdraw the mains plug when making or changing connections.
- DO** consult your dealer if you are ever in doubt about the installation, operation or safety of your equipment.
- DO** be careful with glass panels or doors on equipment.
- DON'T** continue to operate the equipment if you are in any doubt about it working normally, or if it is damaged in any way — switch off, withdraw the mains plug and consult your dealer.
- DON'T** remove any fixed cover as this may expose dangerous voltages.
- DON'T** leave equipment switched on when it is unattended unless it is specifically stated that it is designed for unattended operation or has a standby mode. Switch off using the switch on the equipment and make sure that your family knows how to do this. Special arrangements may need to be made for infirm or handicapped people.
- DON'T** use equipment such as personal stereos or radios so that you are distracted from the requirements of road safety. It is illegal to watch television whilst driving.
- DON'T** listen to headphones at high volume, as such use can permanently damage your hearing.
- DON'T** obstruct the ventilation of the equipment, for example with curtains or soft furnishings. Overheating will cause damage and shorten the life of the equipment.
- DON'T** use makeshift stands and NEVER fix legs with wood screws — to ensure complete safety always fit the manufacturer's approved stand or legs with the fixings provided according to the instructions.
- DON'T** allow electrical equipment to be exposed to rain or moisture.

**ABOVE ALL**

- NEVER let anyone especially children push anything into holes, slots or any other opening in the case — this could result in a fatal electrical shock;
- NEVER guess or take chances with electrical equipment of any kind — it is better to be safe than sorry!

## REMEMBER

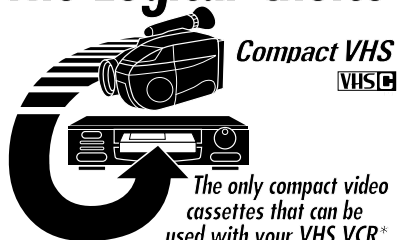
**The Logical Choice**

Compact VHS  
VHS

The only compact video cassettes that can be used with your VHS VCR\*  
with Cassette Adapter

**Programme AE with Special Effects (pg. 22, 23)**

- Electronic Fog Filter
- ND Effect
- Sepia
- Twilight
- Sports
- Nega/Posi
- 1/2000 sec. High Speed Shutter

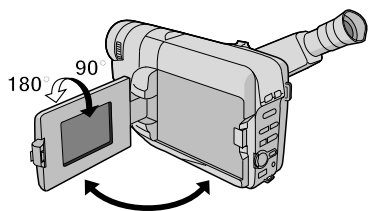
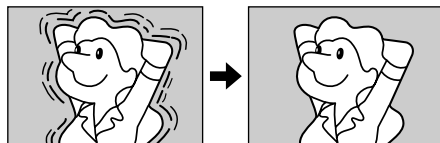
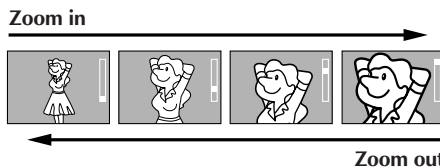
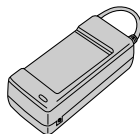
**LCD Colour Monitor (pg. 16)****Menu Adjustment (pg. 26, 27, 28)****Picture Stabilizer (pg. 20)****Digital Hyper Zoom (pg. 18)****PROVIDED ACCESSORIES**

- AC Power Adapter/Charger AA-V16EK

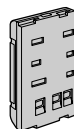

- Battery Pack BN-V11U

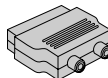

- Cable Adapter

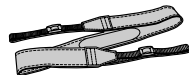

- Shoulder Strap

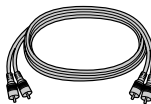

- Audio/Video (A/V) cable

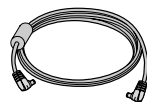

- DC Cord



- Lithium Battery CR2025 x1 for clock operation

## SUPPLY POWER

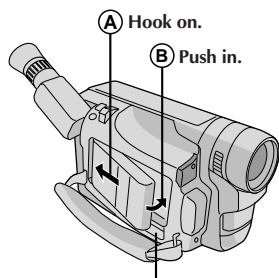

BATTERY RELEASE

### Using the battery pack

Hook its end to the camcorder (A) and push the battery pack in until it locks in place (B).  
(Charging procedure, pg. 6)

### To remove the battery pack

Slide BATTERY RELEASE and pull out the battery pack.

## INSERTING A VIDEO CASSETTE

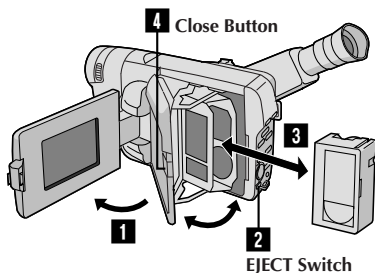

- 1 Open the LCD monitor to an angle of over 60 degrees.
  - 2 Slide EJECT to open the cassette holder.
  - 3 Insert a video cassette.
  - 4 Press the Close button to close the cassette holder.
- (For more details, pg. 11)

## PLAYBACK

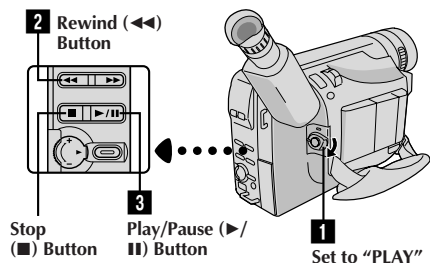

- 1 Set the Power Switch to "PLAY".
  - 2 Press . — The tape will automatically stop at the beginning of the tape.
  - 3 Press . — Playback starts and the playback picture appears.
- To stop playback, press . (For more details, pg. 36)
  - The viewfinder switches off automatically to save power when the LCD monitor is opened at an angle of over 60 degrees.
  - The LCD monitor turns on/off when it is opened/closed at approx. 60 degrees.

Or simply play back the tape on a VHS VCR using the Cassette Adapter (optional) pg. 39

## SHOOTING

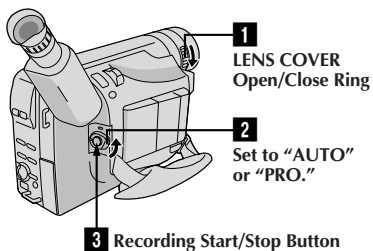

- 1 Turn the LENS COVER Open/Close Ring to open the lens cover.
  - 2 Set the Power Switch to "AUTO" or "PRO.". — The power lamp will light and an image will appear.
  - 3 Press the Recording Start/Stop Button. — Recording starts.
- To stop recording temporarily, momentarily press the Recording Start/Stop Button once again. (For more details, pgs. 14, 15)
  - The viewfinder switches off automatically to save power when the LCD monitor is opened at an angle of over 60 degrees.
  - The LCD monitor turns on/off when it is opened/closed at approx. 60 degrees.

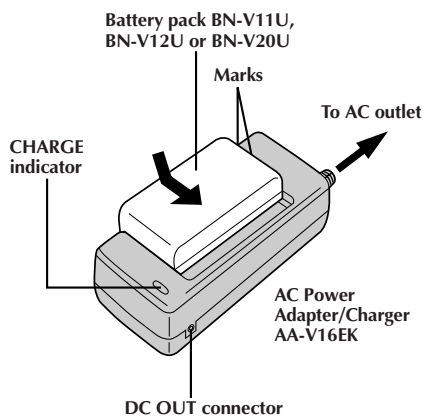

Battery pack	Charging time
BN-V11U	approx. 1 hr. 10 min.
BN-V12U (optional)	approx. 1 hr. 10 min.
BN-V20U (optional)	approx. 1 hr. 50 min.

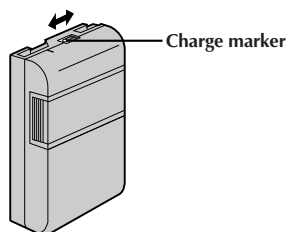

### ATTENTION:

Charging a battery with some charge remaining reduces that battery's capacity. Perform the procedure below to fully discharge the battery pack before recharging.

1. Attach the battery pack to the camcorder and make sure a cassette is **not** inserted, then set the Power Switch to "AUTO" or "PRO."
2. The camcorder power turns off automatically when discharging is complete.

When you are not using a battery pack for a long period of time, be sure to fully discharge it before storing because leaving a battery with some charge left over also reduces performance.

## Power

This camcorder's 3-way power supply system lets you choose the most appropriate source of power. Do not use provided power supply units with other equipment.

## CHARGING THE BATTERY PACK

### 1 SUPPLY POWER

Connect the charger's AC power cord to a wall outlet.

### 2 ATTACH BATTERY PACK

Align the marks and slide the battery pack in the direction of the arrow until it locks in place.

- The CHARGE indicator begins blinking to indicate charging has started.

### 3 DETACH BATTERY PACK

When the CHARGE indicator stops blinking but stays lit, charging is finished. Slide the battery pack opposite the direction of the arrow.

## Charge Marker

A charge marker is provided on the battery pack to help you remember whether it has been charged or not. Two colours are provided (red and black)—you choose which one means charged and which means discharged.

## NOTES:

- Perform charging where the temperature is between 10° and 35°C. 20° to 25°C is the ideal temperature range for charging. If the environment is too cold, charging may be incomplete.
- Charging times noted above are for a fully discharged battery pack.
- Charging time varies according to the ambient temperature and the status of the battery pack.
- To avoid interference with reception, do not use the AC Power Adapter/Charger near a radio.
- If you connect the camcorder's DC cord to the adapter during battery charging, power is supplied to the camcorder and charging stops.
- Since the AC Power Adapter/Charger processes electricity internally, it becomes warm during use. Be sure to use it only in well-ventilated areas.
- When charging the battery pack for the first time or after a long storage period, the CHARGE indicator may not light. In this case, remove the battery pack from the AC Power Adapter/Charger, then try charging again.
- If the battery operation time remains extremely short even after having been fully charged, the battery is worn out and needs to be replaced. Please purchase a new one.
- Remember to set the charge marker after charging a battery pack or after detaching a discharged one from your camcorder.

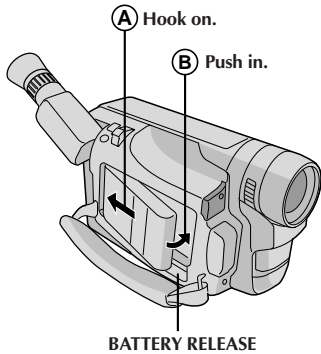

BATTERY RELEASE

**ATTENTION:**

Before detaching the power source, make sure that the camcorder's power is turned off. Failure to do so can result in a camcorder malfunction.

**INFORMATION:**

VU-V856KIT is a set composed of the BN-V856U battery pack and AA-V80EK AC Power Adapter/Charger. Read the VU-V856KIT's instruction manuals before using. It is impossible to charge the BN-V856U battery pack using the provided AC Power Adapter/Charger. Use the optional AA-V80EK AC Power Adapter/Charger.

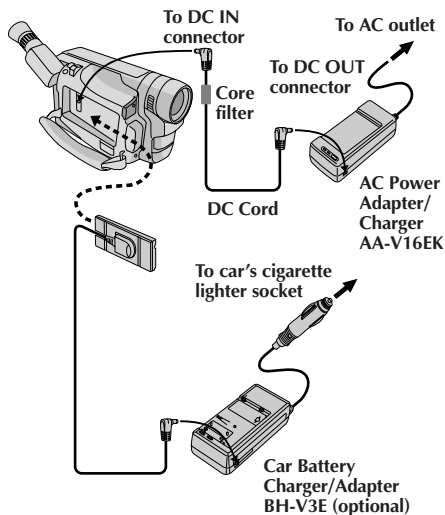
**USING THE BATTERY PACK****1 ATTACH BATTERY PACK**

Hook its end to the camcorder (A) and push the battery pack in until it locks in place (B).

**2 DETACH BATTERY PACK**

Slide BATTERY RELEASE and pull out the battery pack.

**Approximate recording time**

Battery pack	LCD monitor off/ Viewfinder on	LCD monitor on/ Viewfinder off	LCD monitor on/ Viewfinder on
BN-V11U	1 hr. 5 min.	1 hr.	50 min.
BN-V12U (optional)	1 hr. 5 min.	1 hr.	50 min.
BN-V20U (optional)	1 hr. 45 min.	1 hr. 35 min.	1 hr. 25min.
BN-V856U (optional)	7 hrs.	6 hrs. 30 min.	5 hrs. 50 min.

**NOTES:**

- Recording time is reduced significantly under the following conditions:
  - Zoom or Record-Standby mode is engaged repeatedly.
  - The LCD monitor is used repeatedly.
- Before extended use, it is recommended that you prepare enough battery packs to cover 3 times the planned shooting time.

**USING AC POWER**

Use the AC Power Adapter/Charger (connect as shown in the illustration).

**NOTES:**

- The provided AC Power Adapter/Charger features automatic voltage selection in the AC range from 110 V to 240 V.
- For other notes, see pg. 6.

**USING A CAR BATTERY**

Use the optional Car Battery Charger/Adapter (connect as shown in the illustration).

**NOTES:**

- When using the car battery, leave the engine idling.
- The optional Car Battery Charger (BH-V3E) can also be used to charge the battery pack (except BN-V20U/V856U).
- When using the optional Car Battery Charger, refer to the respective instruction booklet.

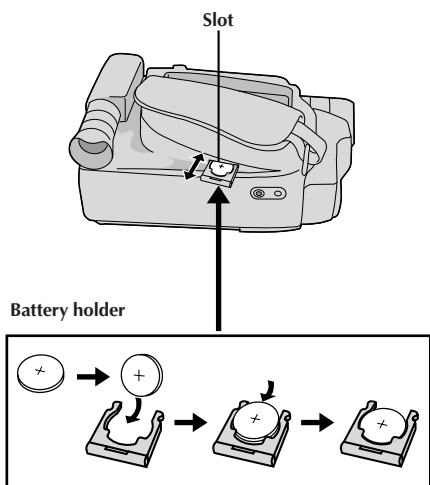

## Clock (Lithium) Battery Insertion/Removal

This battery is necessary for clock operation and to perform date/time settings.

### 1 SWITCH OFF POWER

Switch off the unit's power and remove the power supply unit (battery pack, AC Power Adapter/Battery Charger, etc.).

### 2 REMOVE BATTERY HOLDER

Pull out the battery holder.

### 3 INSERT BATTERY IN HOLDER

Insert the battery in the holder, and be sure to have the "+" mark visible.

### 4 RE-INSERT HOLDER

Slide the holder back into the slot until you hear a click.

## NOTES:

- See "SAFETY PRECAUTIONS" (☞ pg. 2) for information on safe handling of lithium batteries.
- To avoid losing the battery and/or battery holder, place the camcorder with the grip side up as shown in the illustration when inserting/removing the battery.



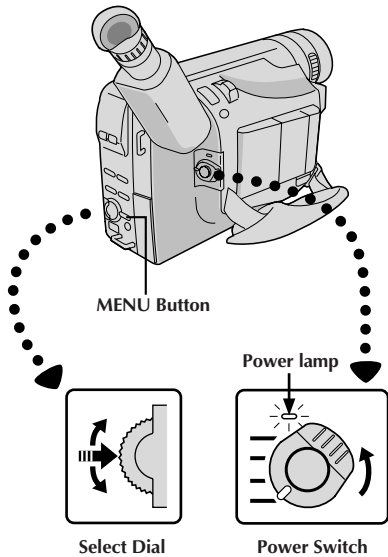

Display

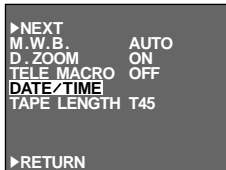

Menu Screen



DATE/TIME Menu

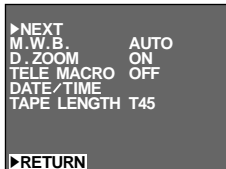

## Date/Time Settings

1

### ACCESS MENU SCREEN

Set the Power Switch to "PRO.", then press MENU.

- The power lamp comes on.

2

### SELECT FUNCTION

Rotate the Select Dial to move the highlight bar to "DATE/TIME", then press it. The DATE/TIME Menu appears.

- If you decide you want to return the date and time to the previous settings, rotate the Select Dial to move the highlight bar to "EXIT" and press it, then go to step 6.
- If you want to set only the time without changing the date, go to step 4.

3

### SET DATE

Rotate the Select Dial to move the highlight bar to the item you want to set and then press it. When the setting begins blinking, rotate the Select Dial until the correct setting appears and then press it. The setting stops blinking.

- Repeat this procedure until you're satisfied with the Date settings ("YEAR", "MONTH" and "DAY").

4

### SET TIME

Rotate the Select Dial to move the highlight bar to "TIME" and then press it. When the hour setting begins blinking, rotate the Select Dial until the correct setting appears and then press it. When the hour setting stops blinking and the minute setting begins blinking, rotate the Select Dial until the correct setting appears and then press it. The minute setting stops blinking.

5

### START CLOCK OPERATION

When none of these settings (YEAR, MONTH, DAY, TIME) blinks, rotate the Select Dial to move the highlight bar to "EXIT", and press it. The Menu Screen reappears with the highlight bar on "RETURN".

6

### CLOSE MENU SCREEN

Press the Select Dial.

## NOTE:

To display the date and time in the camcorder's display and on a connected TV, see "Date/Time Insert" (pg. 24).

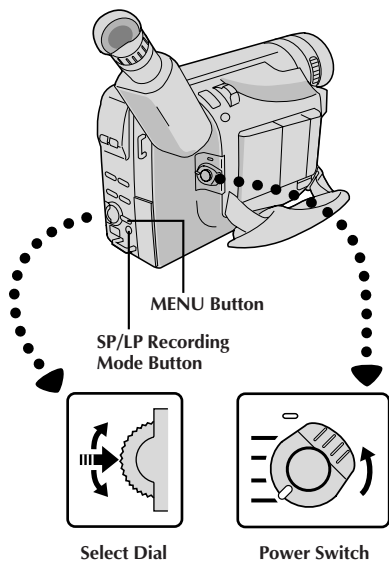

Viewfinder

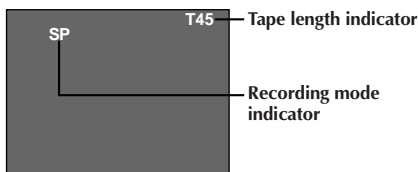

Display

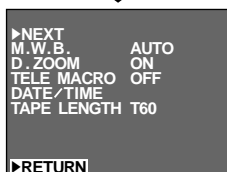
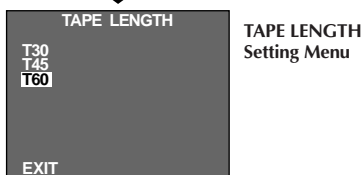
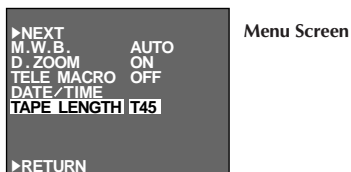

## Recording Mode Setting

Set depending on your preference.

### 1 SET RECORDING MODE

First set the Power Switch to "AUTO" or "PRO.". Press **SP/LP** for more than 1 second. "SP" (Standard Play) provides higher picture and sound quality and is better for dubbing, while "LP" (Long Play) is more economical, providing twice the recording time.

#### NOTE:

If the recording mode is switched during recording, the playback picture will be blurred at the switching point.

## Tape Length Setting

Set the tape length according to the length of the tape used.

### 1 ACCESS MENU SCREEN

First set the Power Switch to "PRO.". Press **MENU**.

### 2 SELECT FUNCTION

Rotate the Select Dial to move the highlight bar to "TAPE LENGTH", then press it. The TAPE LENGTH Setting Menu appears.

### 3 SET TAPE LENGTH

Rotate the Select Dial to move the highlight bar to the correct setting. T30 = 30 minutes of recording time, T45 = 45 minutes, and T60 = 60 minutes.

- If you decide you want to return the tape length to the previous setting, rotate the Select Dial to move the highlight bar to "EXIT".

### 4 CLOSE MENU SCREEN

Press the Select Dial. The Menu Screen reappears with the highlight bar on "RETURN". Press the Select Dial again to close the Menu Screen.

#### NOTE:

The tape remaining time (⏪ pg. 15) displayed in the viewfinder is correct only if the correct tape length has been selected.

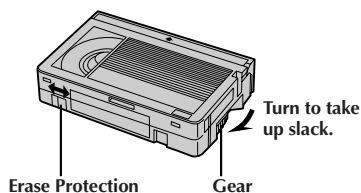
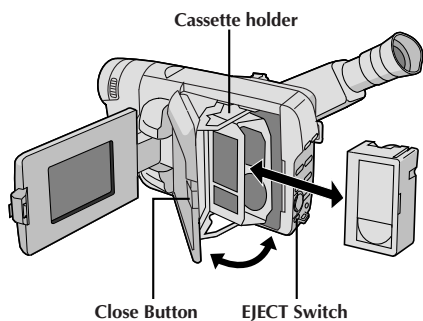

## Loading/Unloading A Cassette

- 1 OPEN LCD MONITOR**  
Open the LCD monitor to an angle of over 60 degrees.
- 2 OPEN CASSETTE HOLDER**  
Slide **EJECT** until the holder opens. Do not use force to open.
- 3 INSERT/REMOVE CASSETTE**  
Make sure the label is facing outward.
- 4 CLOSE CASSETTE HOLDER**  
Press the Close button and make sure the holder is closed and locked.
- 5 CLOSE LCD MONITOR**  
First make sure the holder is closed. Then close the LCD monitor.

### NOTES:

- Closing the LCD monitor while the cassette holder is still open may cause damage to the LCD monitor.
- The cassette holder can't be opened unless a power supply is attached.
- Make sure that the tape is not slack when loading the cassette. If there is any slack, turn the gear on the cassette in the direction of the arrow to take up the slack.
- Make sure the Erase Protection tab is in the position that allows recording. If not, slide the tab. Some cassettes have removable tabs. If the tab has been removed, cover the hole with adhesive tape.
- The cassette holder cannot be opened while the camcorder is in the record mode.

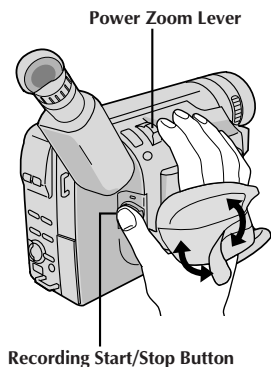

## Grip Adjustment

- 1 EXPAND LOOP**  
Separate the Velcro strip.
- 2 INSERT HAND**  
Pass your right hand through the loop and grasp the grip.
- 3 ADJUST STRAP LENGTH**  
Adjust so that your thumb and fingers can easily operate the Recording Start/Stop Button and Power Zoom Lever. Refasten the Velcro strip.

## Viewfinder Adjustment

- 1 SELECT OPERATION MODE**  
Set the Power Switch to "CAMERA" ("AUTO" or "PRO.").
- 2 POSITION VIEWFINDER**  
Adjust the viewfinder manually for best viewability (see illustration on left).
- 3 ADJUST DIOPTR**  
Turn the Diopter Adjustment Control until the indications in the viewfinder are clearly focused.

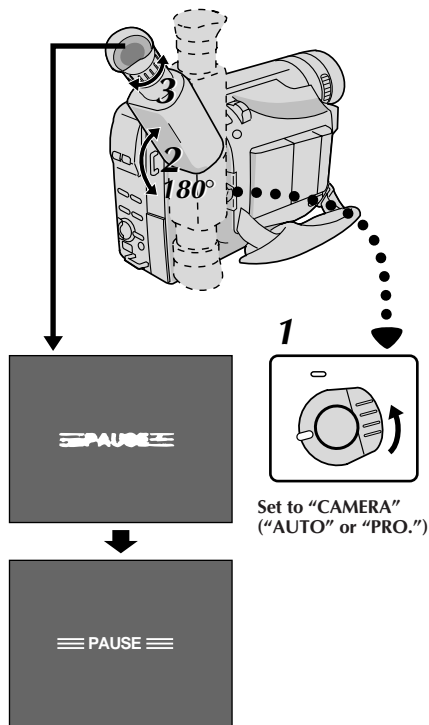

## Shoulder Strap Attachment

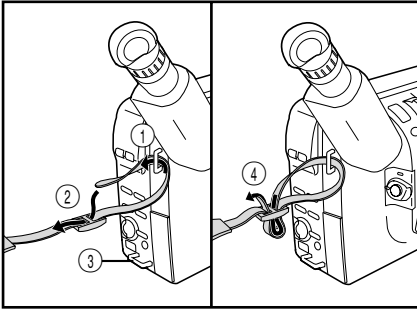

### 1 ATTACH STRAP

Following the illustration on left, thread the strap through the top of the eyelet (1), then fold it back and thread it through the buckle (2). Repeat the procedure to attach the other end of the strap to the other eyelet (3), making sure the strap is not twisted.

### 2 ADJUST LENGTH

Adjust as shown in the illustration on left (4).

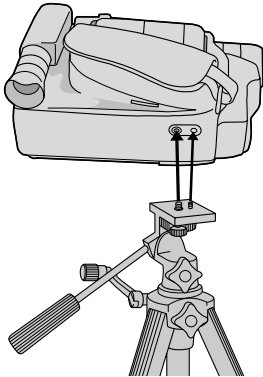

## Tripod Mounting

### 1 ALIGN AND TIGHTEN

Align the screw and camera direction stud on the tripod with the camera's mounting socket and stud hole. Then tighten the screw.

### CAUTION:

When using a tripod, be sure to open and extend its legs fully to stabilise the camcorder. To prevent damage to the unit caused by falling over, do not use a small-sized tripod.

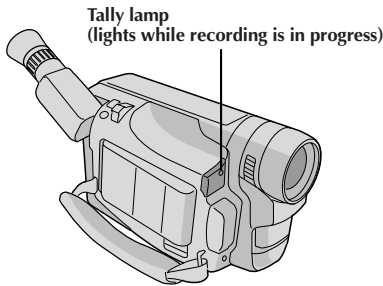
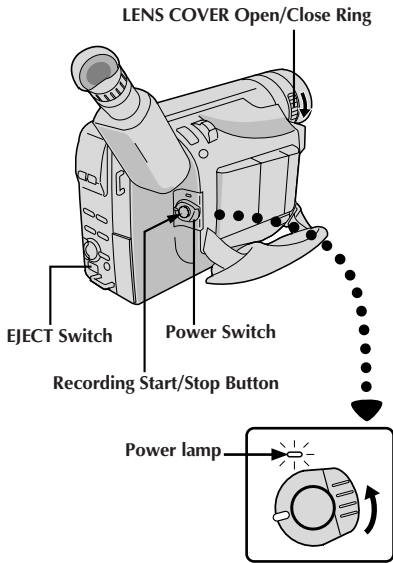
**NOTE:**

You should already have performed the procedures listed below. If not, do so before continuing.

- Power (☞ pg. 6)
- Recording Mode Setting (☞ pg. 10)
- Tape Length Setting (☞ pg. 10)
- Grip Adjustment (☞ pg. 12)
- Viewfinder Adjustment (☞ pg. 12)

**1 LOAD A CASSETTE**

First open the LCD monitor to an angle of over 60 degrees.

Slide **EJECT** to open the cassette holder, then insert the cassette with the label facing out. Press the **Close** button to ensure the holder is closed and locked.

**Shooting While Watching The Viewfinder****2 ENTER RECORD-STANDBY MODE**

Make sure the LCD monitor is closed and locked. Turn the **LENS COVER** Open/Close Ring to open the lens cover, then set the Power Switch to "CAMERA" ("AUTO" or "PRO.").

- The power lamp lights and the camcorder enters the Record-Standby mode.
- The scene you are aimed at appears on the viewfinder screen, with the word "PAUSE" superimposed upon it.

**3 START SHOOTING**

Press the Recording Start/Stop Button.

- "REC" appears in the viewfinder while recording is in progress.

**Power Switch Position**

According to the Power Switch position you have selected, the following functions are available:

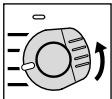

**AUTO**  
(Full Auto mode):

Allows you to record using NO special effects or manual adjustments. Suitable for standard recording.

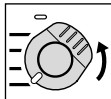

**PRO.**  
(PRO. mode):

Allows you to set various recording functions using the menus. If you want more creative capabilities than full auto recording, try this mode.

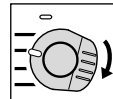

**OFF:**

Allows you to switch off the camcorder.

## Tape remaining time indicator

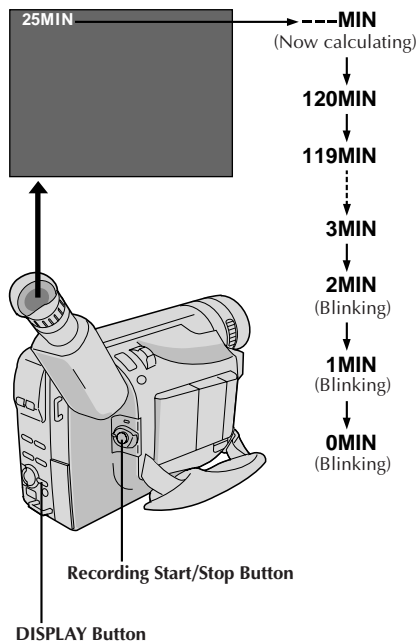

## 4 STOP RECORDING

Press the Recording Start/Stop Button again to stop recording.

- The camcorder re-enters the Record-Standby mode.

### NOTES:

- When the Power Switch is set to "CAMERA" and the LCD monitor is opened at an angle of 60 degrees or more, the LCD monitor switches on and the viewfinder switches off automatically to save power.
- The cassette holder cannot be opened unless a power supply is attached.
- There may be a delay after you slide **EJECT** until the holder opens. Do not use force.
- The tape remaining time is only displayed in the viewfinder as shown.
- The remaining time indicated in the viewfinder is approximate.
- The time required to calculate the remaining tape length, and the accuracy of the calculation, may vary according to the type of tape used.
- The tape remaining time indicator is correct only if the correct tape length has been selected (☞ pg. 10).
- "TAPE END" appears when the tape reaches its end, and the power goes off automatically if left in this condition for 5 minutes. "TAPE END" also appears when a cassette whose tape is already at its end is loaded.
- If the Record-Standby mode continues for 5 minutes without performing Zoom or any other operations, the camcorder's power shuts off automatically. Set the Power Switch to "OFF", and then back to "CAMERA" to turn the camcorder on again.
- If the Recording Start/Stop button is pressed after the Record-Standby mode has continued for over 5 minutes, recording may not start immediately.
- If you are recording on a cassette from the middle (such as when a tape is removed and re-inserted during recording), use the Retake function (☞ pg. 19) to find the end of the last recording so you don't erase any of it.
- The LENS COVER warning blinks for about 5 seconds when the camcorder is turned on with the cover closed.
- While shooting, sound is not heard from the speaker.
- To turn the tally lamp off during recording, refer to pgs. 26 and 28.

## LCD Monitor/Viewfinder Indications

Press **DISPLAY** to make the following indications appear/disappear from the camcorder's display: cassette warning, tape remaining time, battery pack remaining power indicator and tape length indicator (☞ pg. 53).

### 1 PRESS DISPLAY BUTTON

To turn off the indications, press **DISPLAY** for more than 1 second.

Press again for more than 1 second to make the indications reappear.

### NOTE:

Even if the indications are off, the tape remaining time appears blinking when the tape is near its end, and the battery pack remaining power indicator appears blinking when the power is almost gone.

## Shooting While Watching The LCD Monitor

Before the following steps, perform step 1 (pg. 14).

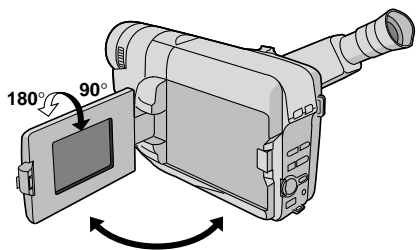

LENS COVER Open/Close Ring

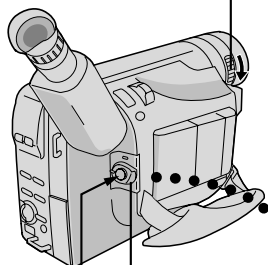

Power Switch

Recording Start/Stop Button

Power lamp

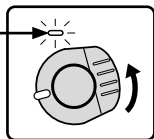

Tally lamp  
(lights while recording is in progress)

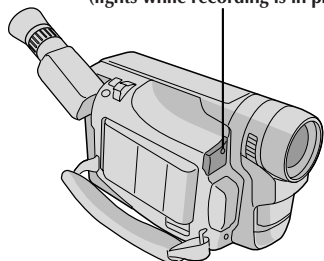

## 2 ENTER RECORD-STANDBY MODE

Make sure the LCD monitor is fully open. Turn the **LENS COVER Open/Close Ring** to open the lens cover, then set the Power Switch to "CAMERA" ("AUTO" or "PRO.").

- The power lamp lights and the camcorder enters the Record-Standby mode.
- The scene you are aimed at appears in the LCD monitor, with the word "PAUSE" superimposed upon it.

## 3 START SHOOTING

Tilt the LCD monitor upward/downward for best visibility (pg. 17) and press the Recording Start/Stop Button.

- "REC" appears in the LCD monitor while recording is in progress.

## 4 STOP RECORDING

Press the Recording Start/Stop Button again to stop recording.

- The camcorder re-enters the Record-Standby mode.

### NOTES:

- When you use the LCD monitor outdoors in direct sunlight, the LCD monitor may be difficult to see. If this happens, we recommend that you use the viewfinder (pg. 14).
- To turn the tally lamp off during recording, refer to pgs. 26 and 28.
- For other notes, refer to pg. 15.



## Journalistic Shooting

In some situations different angles of shooting may be required for more dramatic results.



### 1 OPEN LCD MONITOR

Make sure the LCD monitor is fully open.

### 2 TILT LCD MONITOR

Tilt the LCD monitor in the most convenient direction.

- The LCD monitor can rotate almost full circle (270°: 90° downward, 180° upward).

## Interface Shooting

The person you shoot can view himself/herself in the LCD monitor, and you can even shoot yourself while viewing your own image in the LCD monitor.



Self-recording

### 1 TILT LCD MONITOR UPWARD

Open the LCD monitor and tilt it upward to 180 degrees so that it faces forward.

- When the LCD monitor is tilted upward to an angle of over approx. 105 degrees, the monitor image is inverted vertically, and the viewfinder also switches on.

### 2 START RECORDING

Point the lens toward the subject (yourself when self-recording) and start recording.

- During Interface Shooting, the monitor image and indications do not appear inverted as they would when viewing a mirror.

### NOTE:

*The monitored image can be viewed on the LCD monitor and in the viewfinder.*

## Brightness Control

You can adjust the brightness of the LCD monitor by turning the **BRIGHT** Dial.

### 1 ADJUST BRIGHTNESS

*If you want to brighten the image . . .*

Turn the Dial towards "+".

*If you want to darken the image . . .*

Turn the Dial towards "-".

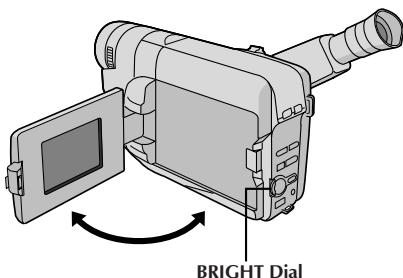

BRIGHT Dial

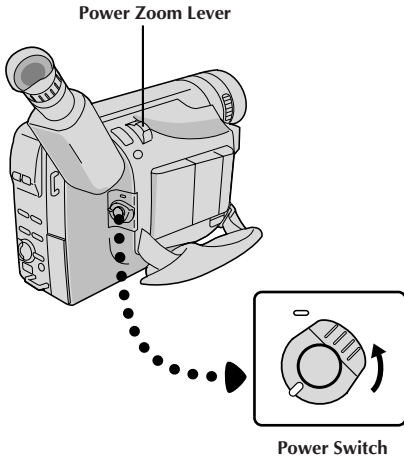
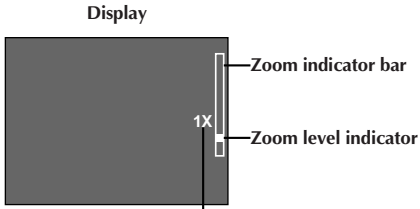
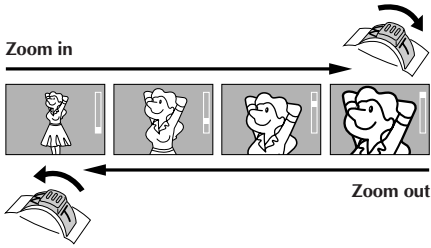

## FEATURE: Zooming

### PURPOSE:

To produce the zoom in/out effect, or an instantaneous change in image magnification. Digital circuitry extends the maximum magnification offered by optical zoom. This system is called Digital Zoom.

### OPERATION:

#### Zoom In

Push the Power Zoom Lever towards "T".

#### Zoom Out

Push the Power Zoom Lever towards "W".

- The harder you push the Power Zoom Lever, the quicker the zoom action.

### NOTES:

- Focusing may become unstable during Zooming. In this case, set the zoom while in Record-Standby, lock the focus by using the manual focus (☞ pg. 31), then zoom in or out in Record mode.
- The zoom level indicator (■) moves during zoom. Once the zoom level indicator reaches the top of the zoom indicator bar, all magnification from that point is through digital processing.
- When using Digital Zoom, the quality of image may suffer. To deactivate Digital Zoom, set "D.ZOOM" to "OFF" in the Menu Screen (☞ pg. 27).

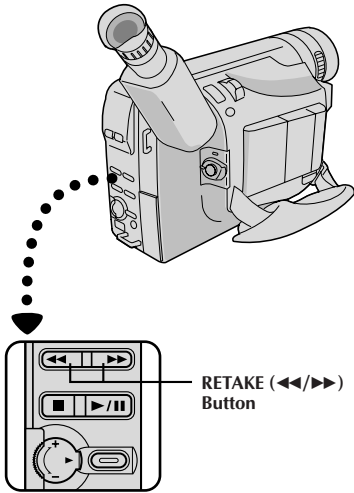

### FEATURE: Quick Review

#### PURPOSE:

To check the end of the last recording.

#### OPERATION:

- 1) Press ◀ and release quickly during the Record–Standby mode.
- Tape is rewound for about 1 second and played back automatically, then pauses in Record–Standby mode for the next shot.

#### NOTE:

*Distortion may occur at the start of playback. This is normal.*

### FEATURE: Retake

#### PURPOSE:

To re-record certain segments.

#### OPERATION:

- 1) Make sure the camcorder is in the Record–Standby mode.
- 2) Press and hold either **RETAKE** to reach the start point for new recording. Pressing ▶ forwards the tape and pressing ◀ reverses it.
- 3) Press the Recording Start/Stop Button to start recording.

#### NOTE:

*Noise bars appear and pictures may become monochrome or darken during Retake. This is normal.*

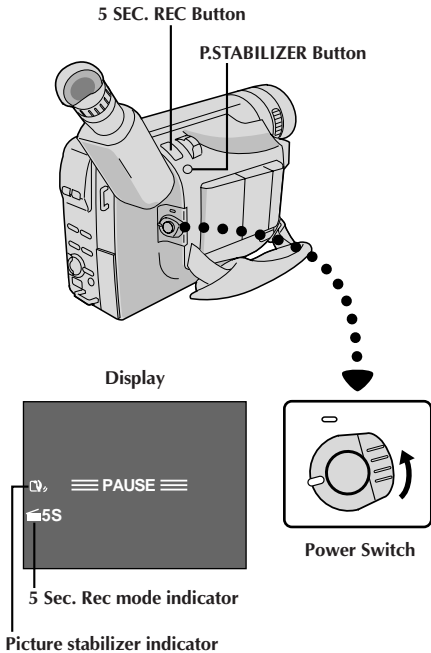
**FEATURE: Picture Stabilizer****PURPOSE:**

To compensate for unstable images caused by camera-shake, particularly at high magnification.

**OPERATION:**

- 1) Press **P.STABILIZER**. "P" appears.
  - To switch off the Picture Stabilizer, press **P.STABILIZER**. The indicator disappears.

**NOTES:**

- Accurate stabilisation may not be possible if hand shake is excessive, or under the following conditions:
  - When shooting subjects with vertical or horizontal stripes.
  - When shooting dark or dim subjects.
  - When shooting subjects with excessive backlighting.
  - When shooting scenes with movement in various directions.
  - When shooting scenes with low-contrast backgrounds.
- Switch off the Picture Stabilizer when recording with the camcorder on a tripod.
- The "P" indicator appears blinking if the Stabilizer cannot be used.

**FEATURE: 5Sec. Rec (5-sec. Recording)****PURPOSE:**

To record a scene for 5 seconds, providing quick scene transitions like those seen in TV programmes.

**OPERATION:**

- 1) During Record-Standby, press **5SEC. REC**. "5S" appears and 5Sec. Rec is reserved.
- 2) Press the Recording Start/Stop Button. Recording starts, and after 5-second recording is finished, the camcorder reenters the Record-Standby mode automatically.
  - To cancel the 5Sec. Rec. function, press **5SEC. REC** again so that "5S" disappears.

**NOTE:**

*Fade/Wipe* (pg. 21) cannot be activated by pressing **5SEC. REC**.

[Ex.: Fader]

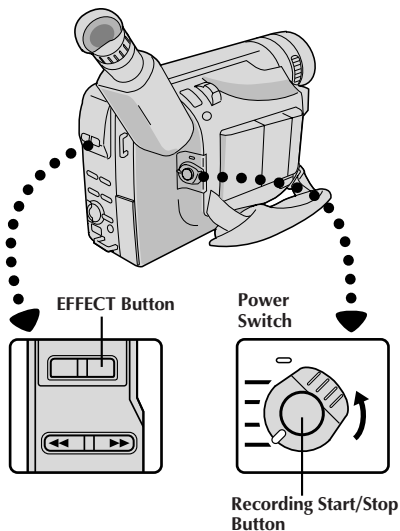
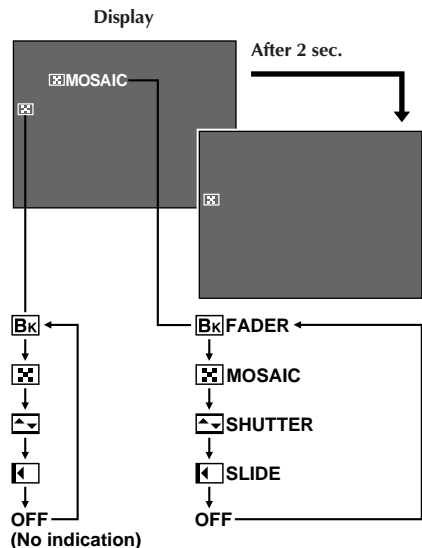

## Fade/Wipe

These effects let you make pro-style scene transitions. Fade- or wipe-in works at recording start, and fade- or wipe-out works at recording end.

### 1 SELECT OPERATION MODE

Set the Power Switch to "PRO."

### 2 ENGAGE FADE- OR WIPE-STANDBY MODE

Press **EFFECT** to cycle through the modes as shown at left. Once the desired mode appears, it is selected and reserved.

- The selected mode's name and its indication are displayed for approx. 2 seconds. Then the name disappears, and only the indication remains.

### 3 START OR END RECORDING

Press the Recording Start/Stop Button to activate fade-in/out or wipe-in/out.

### 4 TO CANCEL FADE- OR WIPE-STANDBY MODE

Press **EFFECT** repeatedly until "OFF" appears.

- "OFF" is displayed for approx. 2 seconds and the fade/wipe standby mode is canceled.

#### **Bk** FADER

Fades in/out to a black screen.

#### **MOSAIC** (Fader)

Gradually turns/returns the picture into/from a mosaic pattern.

#### **SHUTTER** (Wipe)

A black screen moves in from the top and bottom, closing over the image like a shutter, or a new image pushes open the black screen vertically from the centre.

#### **SLIDE** (Wipe)

A black screen moves in from the left to gradually cover the image, or a new image moves in from right to left.

## NOTES:

- Pressing and holding the Recording Start/Stop Button allows you to vary the length for the image during fade in/out or wipe in/out.
- The screen becomes slightly reddish when the Fade/Wipe is used with Sepia (pg. 23).
- With the Electronic fog filter mode (pg. 23) engaged, the image fades in/out to a white screen.

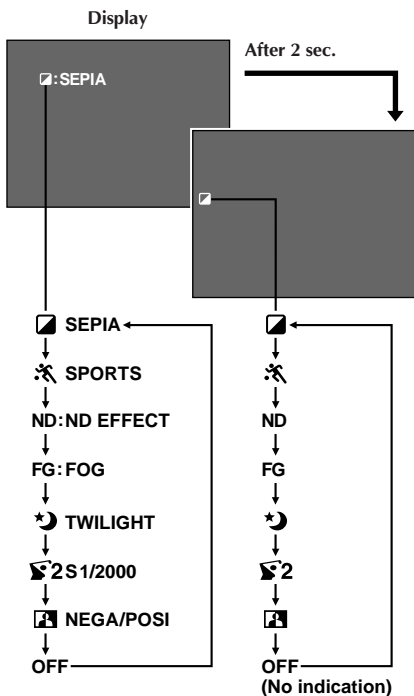

## Programme AE With Special Effects

All you have to do to access any of the variety of shooting effects is press **P.AE**.

### 1 SELECT OPERATION MODE

Set the Power Switch to "PRO."

### 2 SELECT MODE

Press **P.AE** to cycle through the modes as shown on the left.

- The selected mode's name and its indication are displayed for approx. 2 seconds. Then the name disappears, and only the indication remains. The mode is activated.

### NOTES:

- Only one mode can be engaged at a time.
- The screen becomes slightly reddish when the Fade/Wipe (pg. 21) is used in the Sepia mode.
- The screen becomes slightly dark in the High Speed Shutter mode. Use in well-lit situations.
- In the "High Speed Shutter" or "Sports" modes, picture colour may be adversely affected if the subject is lit by alternating discharge-type light sources such as fluorescent or mercury-vapour lights.

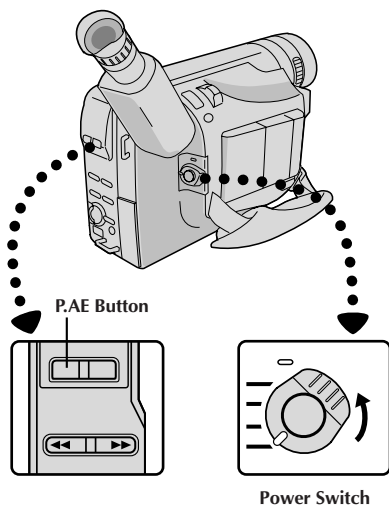

Display

Mode

**Sepia**

The scene being shot is recorded in sepia-tinted (reddish-brown) monochrome, giving the effect of an older movie. Use together with Wide (📖 pg. 27) for the authentic look of a classic Hollywood movie.

**Sports**

High shutter speed clearly captures fast-moving action.

**ND Effect**

A black mist darkens the picture, as when an ND filter is used. Helps to counter the effects of glare on the subject.

**Electronic Fog Filter**

Makes the picture look misty white, as when an external fog filter is attached to the lens. Softens the image and gives it a “fantasy” look.

**Twilight**

Dusk, twilight scenery, fireworks, etc., look more natural and dramatic. The following happens when Twilight mode is selected:

- Auto gain control is turned off.
- White Balance is set to “☀: FINE” (day mode), but can also be manually changed to another mode (📖 pg. 32).
- Auto Focus becomes available only in the range of 10 m to infinity. To focus when the subject-to-camera distance is less than 10 m, use manual focusing (📖 pg. 31).

Display

Mode

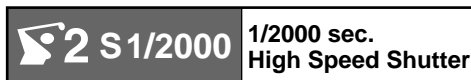
**High-Speed Shutter (1/2000s.)**

Captures faster action than Sports mode.

**Nega/Posi (Negative/Positive)**

The colours of a picture are reversed.

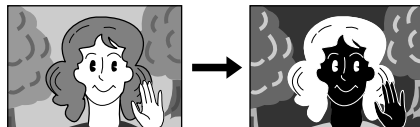
**NEGA POSI mode**

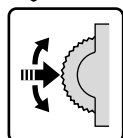
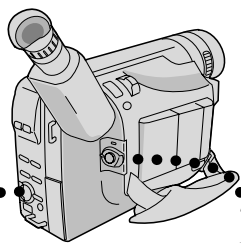

Select Dial

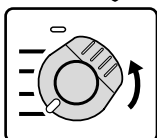

Power Switch

Display

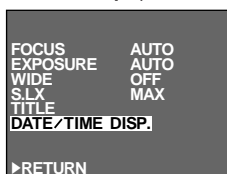

Menu Screen

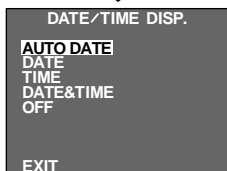
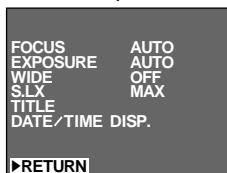
DATE/TIME DISP.  
Menu

AUTO DATE ←

25. 12. 99  
↓ (DATE)22: 50: 00  
↓ (TIME)25. 12. 99 22: 50: 00  
↓ (DATE&TIME)OFF  
(No indication)

## Date/Time Insert

The feature allows you to display the date and time on the LCD monitor, in the viewfinder, or on a connected colour monitor, as well as to record them manually or automatically.

### 1 SELECT OPERATION MODE

Set the Power Switch to "PRO."

### 2 ACCESS MENU SCREEN

Press the Select Dial to display the Menu Screen.

### 3 ACCESS "DATE/TIME DISP." MENU

Move the highlight bar to "DATE/TIME DISP." by rotating the Select Dial. Then press it to display the DATE/TIME DISP. Menu.

### 4 SELECT THE DESIRED MODE

Move the highlight bar to the desired mode by rotating the Select Dial, then press it. The desired mode is activated.

- You should have already performed the Date/Time Setting procedure (☞ pg. 9). If you haven't, do so first.

### 5 CLOSE MENU SCREEN

The Menu Screen reappears with the highlight bar on "RETURN". Then press the Select Dial to close the Menu Screen.

## NOTES:

### DISPLAY

- The selected display can be recorded.
- If you do not want to record the display, select the OFF mode before shooting.

### AUTO DATE

- Your camcorder automatically records the date for about 5 seconds after recording is initiated in the following situations:
  - After changing the date.
  - After loading a cassette.
  - After Auto Date Record mode is selected by rotating the Select Dial.
- In this mode, the date is replaced after 5 seconds with "AUTO DATE" but this is not recorded.



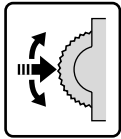
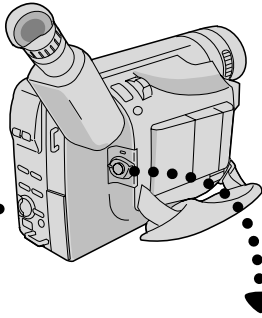

Select Dial

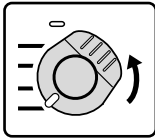

Power Switch

Display

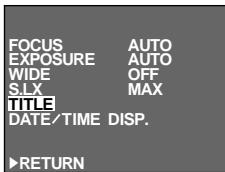

Menu Screen



TITLE Menu

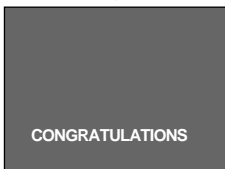
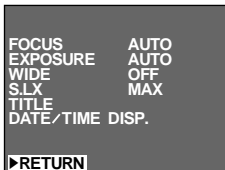

## Instant Titles

The camcorder has eight preset titles in memory. You can superimpose one of them over a picture as shown in the illustration on left.

### 1 SELECT OPERATION MODE

Set the Power Switch to "PRO."

### 2 ACCESS MENU SCREEN

Press the Select Dial to display the Menu Screen.

### 3 ACCESS "TITLE" MENU

Move the highlight bar to "TITLE" by rotating the Select Dial. Then press it to display the TITLE Menu.

### 4 SELECT THE DESIRED MODE

Move the highlight bar to the desired mode by rotating the Select Dial, then press it. The desired mode is activated.

- If you wish to make the title indication disappear, select "OFF".

### 5 CLOSE MENU SCREEN

The Menu Screen reappears with the highlight bar on "RETURN". Then press the Select Dial to close the Menu Screen.

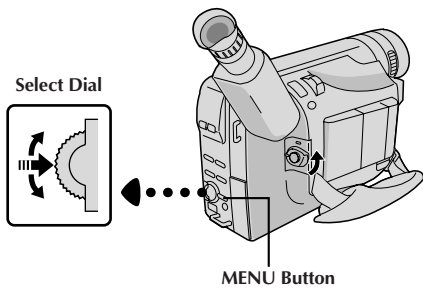

Display  
(ex. Menu Screen available  
using the MENU Button)

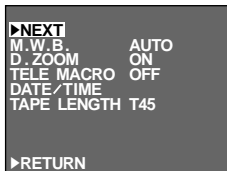

Menu Screen 1

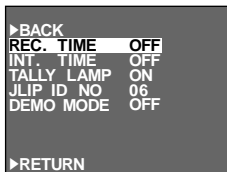

Menu Screen 2

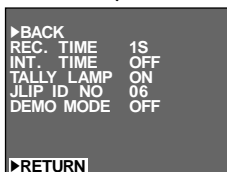
Setting Menu  
(ex. REC TIME)

Normal Screen



## Using Menu For Detailed Adjustment

This camcorder is equipped with an easy-to-use, on-screen menu system that simplifies many of the more detailed camcorder settings.

### 1 SELECT OPERATION MODE

Turn the Power Switch to "PRO."

### 2 ACCESS MENU SCREEN

Menu access depends on the function you select.

*If you select the functions from the "Menu Screen Available Using The Select Dial" described on pg. 27 . . .*

.... press the Select Dial. The Menu Screen appears.

*If you select the functions from the "Menu Screen Available Using The MENU Button" described on pg. 27 and 28 . . .*

.... press MENU. The Menu Screen appears.

### 3 SELECT FUNCTION

Rotate the Select Dial to place the highlight bar on the desired function.

- To go from Menu Screen 1 to Menu Screen 2, rotate the Select Dial to "NEXT" and press it. To go back to Menu Screen 1 from Menu Screen 2, rotate the Select Dial to "BACK", and press it.
- If the setting you want cannot be found in the Menu Screen, place the highlight bar on "RETURN", then go to step 6.

### 4 MAKE SETTING

Press the Select Dial. The setting procedure depends on the function you select.

*If you select "FOCUS", "EXPOSURE", "TITLE", "DATE/TIME DISP." or "DATE/TIME" . . .*

.... see respective pages (FOCUS: pg. 30, 31,

EXPOSURE: pg. 29, TITLE: pg. 25,

DATE/TIME DISP.: pg. 24, DATE/TIME: pg. 9).

*If you select "WIDE", "D.ZOOM", "TELE MACRO" or "DEMO MODE" . . .*

.... the selected function's parameter starts blinking.

Rotate the Select Dial until the desired parameter appears. Go to step 5.

*If you select "J-LIP ID NO." . . .*

.... press the Select Dial so that the number blinks, then rotate it until the desired number appears, and press it. Then rotate the Select Dial to move the highlight bar to "EXIT".

*If you select any other functions . . .*

.... rotate the Select Dial to move the highlight bar to the desired setting.

- If you decide you want to return to the previous setting, rotate the Select Dial to move the highlight bar to "EXIT".

### 5 END SETTING

Press the Select Dial. The Menu Screen reappears with the highlight bar on "RETURN".

### 6 CLOSE MENU SCREEN

Press the Select Dial. The normal screen reappears.

## NOTE:

No menu functions except "FOCUS" and "EXPOSURE" are available while in the Record mode.



## MENU SCREEN EXPLANATIONS

### Menu Screen Available Using The Select Dial

<b>FOCUS</b>	<b>AUTO</b>	Adjusts focus automatically.
	<b>MANU</b>	Allows you to adjust focus manually (☞ pg. 30, 31).
<b>EXPOSURE</b>	<b>AUTO</b>	Adjusts exposure automatically.
	<b>MANU</b>	Allows you to adjust exposure manually (☞ pg. 29).
<b>WIDE</b>	<b>OFF</b>	Does not display black bars.
	<b>ON</b>	Allows you to record black bars at the top and bottom of the screen to produce a cinema-like “wide-screen” effect.
<b>S.LX</b>	<b>MAX</b>	To record a subject in a darkly lit environment, when it is more convenient to shoot the subject with a brighter image even if the picture becomes slightly coarse.
	<b>NORMAL</b>	To record a subject in a dimly lit environment, when it is more convenient to shoot with a less coarse picture although the subject becomes slightly dark.
	<b>OFF</b>	Allows you to shoot dark scenes with no picture brightness adjustment.
<b>TITLE</b>	Allows you to superimpose one of eight preset titles (☞ pg. 25).	
<b>DATE/TIME DISP.</b>	Makes the date/time settings appear in the camcorder or on a connected monitor (☞ pg. 24).	

### Menu Screen Available Using The MENU Button

This Menu Screen cannot be accessed while recording.

<b>M.W.B.</b>	<b>AUTO</b>	This camcorder's Automatic Colour Temperature system senses the colour temperature of the ambient lighting for automatic white balance adjustment. However, precise colour adjustment is not possible under the following conditions: <ul style="list-style-type: none"> <li>• When an object is in various shades of the same colour.</li> <li>• When a predominantly red or brown object is being shot outdoors.</li> </ul> In these cases, use the camcorder's built-in preset filters for white balance adjustment (☞ pg. 32, 33).
	 : <b>FINE</b>	
	 : <b>CLOUD</b>	
	 : <b>HALOGEN</b>	
	<b>MWB</b>	
<b>D. ZOOM</b>	<b>ON</b>	Allows you to use the Digital Zoom. By digitally processing and magnifying images, zooming is possible from 16 times (the optical zoom limit), to a maximum of 50 times digital magnification.
	<b>OFF</b>	Digital Zoom is not available. Only optical zoom (maximum 16x magnification) can function. When set to “OFF” during Digital Zoom, zoom magnification changes to 16x.
<b>TELE MACRO</b>	<b>OFF</b>	Usually the distance to a subject where the lens is in focus depends on the zoom magnification. Unless there is a distance of more than 1m to the subject, the lens is out of focus at the maximum telephoto setting. When set to “ON”, you can shoot a subject as large as possible at a distance of approx. 60 cm. <ul style="list-style-type: none"> <li>• Depending on the zoom position, the lens may go out of focus.</li> </ul>
	<b>ON</b>	

 : Factory-preset

CONTINUED ON NEXT PAGE

## Menu Screen Available Using The MENU Button (cont.)

<b>DATE/TIME</b>	Allows you to set the current date and time (☞ pg. 9).	
<b>TAPE LENGTH</b>	Allows you to set the tape length depending on the tape used (☞ pg. 10).	
<b>REC TIME</b>	This feature allows you to set the parameters for Animation and Time-Lapse recording (☞ pg. 35).	
<b>INT. TIME</b>	This feature allows you to set the parameters for Self-Timer (☞ pg. 34) and Time-Lapse recording (☞ pg. 35).	
<b>TALLY LAMP</b>	<b>OFF</b>	The tally lamp remains off at all times.
	<b>ON</b>	The tally lamp comes on to signal the start of recording.
<b>JLIP ID NO.</b>	This number is necessary when connecting the camcorder to a device such as a computer using the J terminal (JLIP). The numbers range from 01 to 99. Factory setting is 06.	
<b>DEMO MODE</b>	<b>OFF</b>	Automatic demonstration will not take place.
	<b>ON</b>	<p>Demonstrates certain functions such as Fade/Wipe, etc. When "DEMO MODE" is set to "ON" and the Menu Screen is closed, the demonstration starts.</p> <p><b>NOTES:</b></p> <ul style="list-style-type: none"> <li>● When a tape whose Erase Protection tab is in the position that allows recording is loaded in the camcorder, demonstration is not available.</li> <li>● By turning off the camcorder or inserting a tape whose Erase Protection tab is in the position that allows recording into it, "DEMO MODE" is set to "OFF" automatically.</li> <li>● During the demonstration, all functions except zoom are disabled.</li> </ul>

 : Factory-preset

## Exposure Control

This feature automatically adjusts the iris for the best available picture quality, but you can override and make the adjustment manually.

- 1 SELECT OPERATION MODE**  
Set the Power Switch to "PRO."
- 2 ACCESS MENU SCREEN**  
Press the Select Dial to display the Menu Screen.
- 3 ACCESS "EXPOSURE" MENU**  
Rotate the Select Dial to move the highlight bar to "EXPOSURE" and press it.
- 4 ACCESS MANUAL EXPOSURE**  
Rotate the Select Dial to move the highlight bar to "MANU", then press it. "00" (exposure control level counter) appears.
- 5 ADJUST EXPOSURE**  
*To brighten the image . . .*  
.... rotate the Select Dial upward. The exposure control level counter increases (maximum +06).  
Go to step 6.  
*To darken the image . . .*  
.... rotate the Select Dial downward. The exposure control level counter decreases (maximum -06).  
Go to step 6.
- 6 END ADJUSTMENT OF EXPOSURE**  
Press the Select Dial. The Menu Screen reappears with the highlight bar on "RETURN".
- 7 CLOSE MENU SCREEN**  
Press the Select Dial. The Menu Screen disappears and the exposure control level counter reappears to indicate the exposure is adjusted.

### NOTES:

- To return to the factory setting, select "AUTO" in step 4.
- To re-adjust exposure, repeat the procedure from step 2.

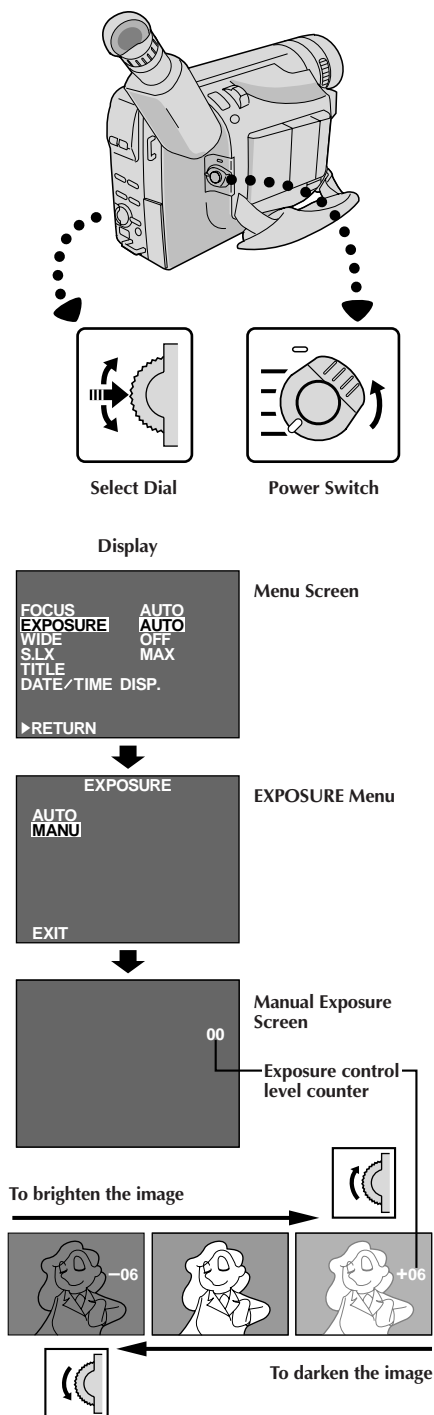

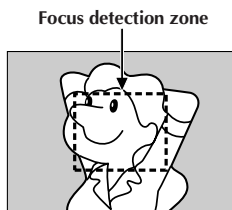

## Focusing

### AUTO FOCUS

The camcorder's Full Range AF system offers continuous shooting ability from close-up to infinity. However, correct focus may not be obtainable in the situations listed below (in these cases use manual focusing):

- When two subjects overlap in the same scene.
- When illumination is low.\*
- When the subject has no contrast (difference in brightness and darkness), such as a flat, one-colour wall, or a clear, blue sky.\*
- When a dark object is barely visible in the viewfinder.\*
- When the scene contains minute patterns or identical patterns that are regularly repeated.
- When the scene is affected by sunbeams or light reflecting off the surface of a body of water.
- When shooting a scene with a high-contrast background.

\* The low-contrast warning “▲▲” appears.

### NOTES:

- If the lens is smeared or blurred, accurate focusing is not possible. Keep the lens clean, wiping with a piece of soft cloth if it gets dirty. When condensation occurs, wipe with a soft cloth or wait for it to dry naturally.
- When shooting a subject close to the lens, zoom out first (☞ pg. 18). If zoomed in in the auto focus mode, the camcorder could automatically zoom out depending on the distance between the camcorder and the subject. When Tele Macro (☞ pg. 27) is activated, the camcorder will not zoom out automatically.

## MANUAL FOCUS

**NOTE:**

You should already have made the necessary viewfinder adjustments (☞ pg. 12). If you haven't, do so before continuing.

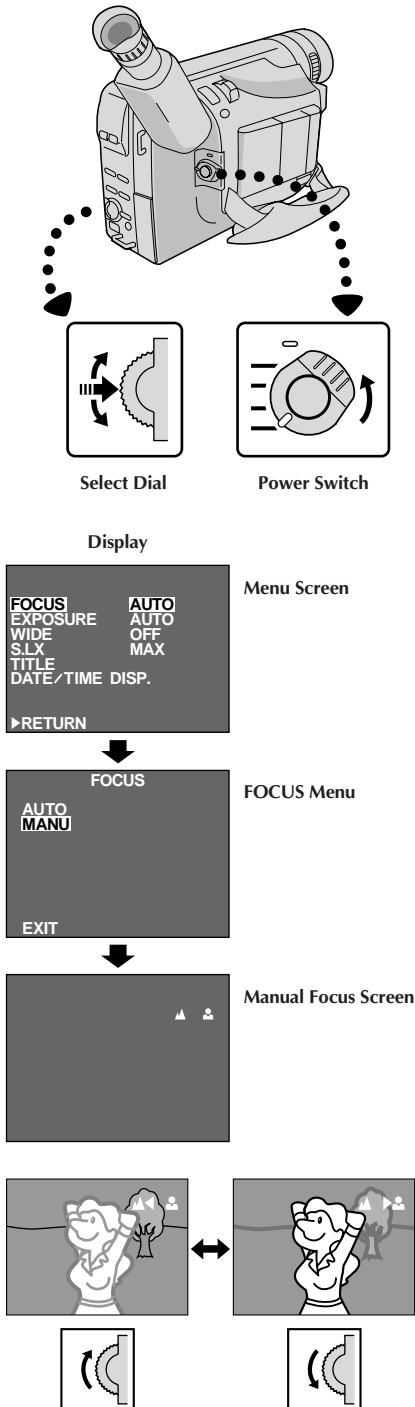
**1 SELECT OPERATION MODE**

Set the Power Switch to "PRO."

**2 ACCESS MENU SCREEN**

Press the Select Dial to display the Menu Screen.

**3 ACCESS "FOCUS" MENU**

Move the highlight bar to "FOCUS" by rotating the Select Dial, then press it.

**4 ACCESS MANUAL FOCUS**

Rotate the Select Dial to move the highlight bar to "MANU", then press it. "▲" and "●" appear. The focus is locked at this point.

**5 ADJUST FOCUS**

*To farther subject . . .*

.... rotate the Select Dial upward. "◀" appears and blinks.

Go to step 6.

*To nearer subject . . .*

.... rotate the Select Dial downward. "▶" appears and blinks.

Go to step 6.

**6 END ADJUSTMENT OF FOCUS**

Press the Select Dial. The Menu Screen reappears with the highlight bar on "RETURN".

**7 CLOSE MENU SCREEN**

Press the Select Dial. The Menu Screen disappears and "▲●" reappears to indicate the focus is locked.

**NOTES:**

- To return to Auto Focus, select "AUTO" in step 4.
- To re-adjust Manual Focus, repeat the procedure from step 2.
- Be sure to focus the lens in the maximum telephoto position when you use the Manual Focus mode. If you focus in on a certain subject in the wide-angle position, sharply focused images cannot be obtained when zoomed in because the depth-of-field is reduced at longer focal lengths.
- When the focus level cannot be adjusted any farther or closer, "▲" or "●" will blink.

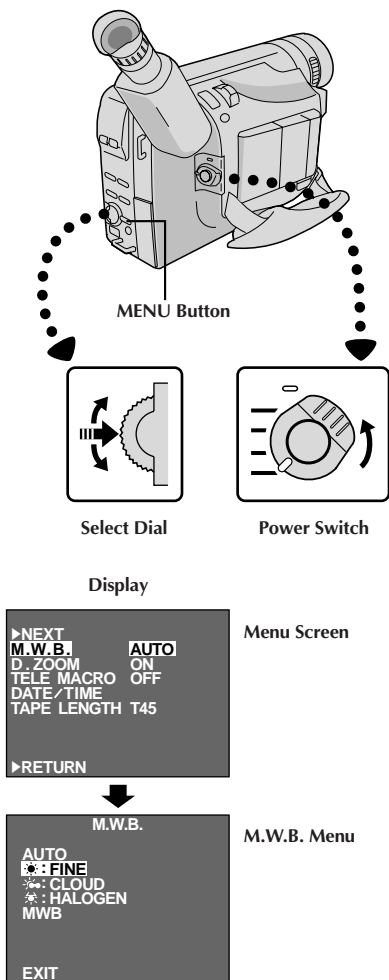

## White Balance Adjustment

A term that refers to the correctness of colour reproduction under various lighting. If the white balance is correct, all other colours will be accurately reproduced. The white balance is usually adjusted automatically. However, the more advanced camcorder operator would prefer to control this function manually and achieve a more professional colour/tint reproduction.

### 1 SELECT OPERATION MODE

Set the Power Switch to "PRO".

### 2 ACCESS MENU SCREEN

Press MENU. The Menu Screen appears.

### 3 ACCESS WHITE BALANCE ADJUSTMENT

Move the highlight bar to "M.W.B." by rotating the Select Dial, then press it. The Menu Screen disappears and the "M.W.B." Menu appears.

### 4 SET FUNCTION PARAMETERS

Move the highlight bar to the required white balance by rotating the Select Dial.

#### "AUTO"

The white balance is adjusted automatically. This is the factory preset position.

#### "☀️" : FINE"

When shooting outdoors on a sunny day.

#### "☁️" : CLOUD"

When shooting outdoors on a cloudy day.

#### "💡" : HALOGEN"

When using a video light or other similar type of lighting.

#### "MWB"

When shooting with the white balance already having been set on the subject (To set "MWB", see pg. 33).

### 5 CLOSE MENU SCREEN

Press the Select Dial.

The Menu Screen reappears with the highlight bar on "RETURN". Press the Select Dial again to close the Menu Screen.

#### To Return To Automatic White Balance . . .

.... select "AUTO" in step 4. Or set the Power Switch to "AUTO".

## NOTE:

White balance cannot be used when Sepia (see pg. 23) is activated.



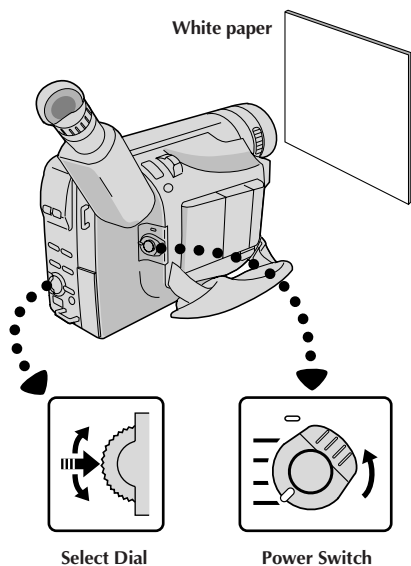

Display

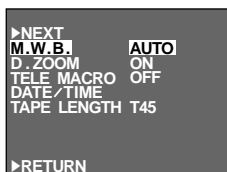

Menu Screen

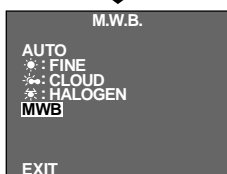

M.W.B. Menu

## Manual White Balance Operation

If the camera is operating in PRO. mode, perform a Manual White Balance when shooting under various types of lighting.

- 1 SELECT OPERATION MODE**  
Follow steps 1 through 4 of the white balance adjustment (☞ pg. 32), and select “MWB”.
- 2 SET MANUAL WHITE BALANCE**  
Hold a sheet of plain white paper in front of the subject. Adjust zoom or position yourself so that the white paper fills the screen.
- 3 ENTER SETTING**  
Press the Select Dial until “MWB” begins blinking.
  - When the setting is completed, “MWB” stops blinking, and the Menu Screen reappears with the highlight bar on “RETURN”.
- 4 CLOSE MENU SCREEN**  
Press the Select Dial again to close the Menu Screen.

### To Change The Tint For Recording . . .

.... in step 2, substitute coloured paper for white. The white balance is adjusted based on the colour, changing the tint. Red paper — deeper green; blue paper — orange; yellow paper — deeper purple.

### NOTES:

- In step 2, it may be difficult to focus on the white paper in some circumstances. In such a case, adjust focus manually (☞ pg. 31).
- A subject can be shot under various types of lighting conditions indoors (natural, fluorescent, candlelight, etc.). Because the colour temperature is different depending on the light source, the tint of the subject will differ depending on the white balance settings. Use this function for a more natural result.
- Once you adjust white balance during Manual White Balance operation, the setting is retained even if the power is turned off or the battery removed.

## Self-Timer

You can set the delay between pressing the Recording Start/Stop button and the actual start of recording. If you secure the camcorder, you (or whoever is operating the camcorder) can enter the scene before recording starts.

### NOTE:

Make sure the Power Switch is set to "PRO." and the camcorder is in the Record-Standby mode before performing the following steps.

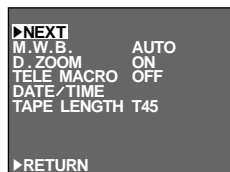
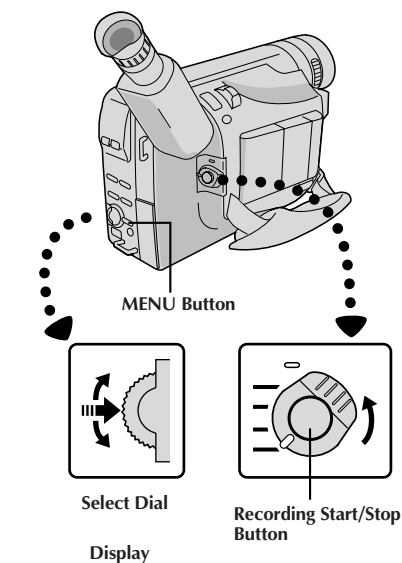

Menu Screen 1

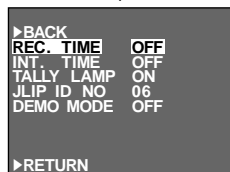

Menu Screen 2



INT. TIME Menu

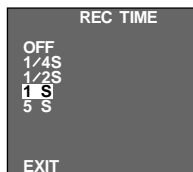

REC TIME Menu

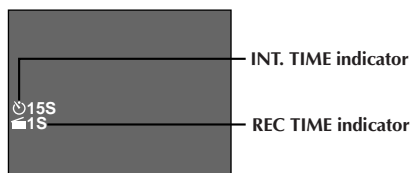

INT.TIME and REC TIME indications on the normal screen

### 1 ACCESS MENU SCREEN

Press MENU.

### 2 ACCESS "INT. TIME" MENU

Rotate the Select Dial to move the highlight bar to "NEXT" in Menu Screen 1 and press it to display Menu Screen 2. Then, move the highlight bar to "INT. TIME" and press it.

### 3 SET INTERVAL TIME

Rotate the Select Dial to move the highlight bar to the desired time, then press it. The Menu Screen reappears with the highlight bar on "RETURN".

### 4 CLOSE MENU SCREEN

Press the Select Dial.

### 5 START DELAYED RECORDING

Press the Recording Start/Stop Button. When the selected time has elapsed, recording begins automatically.

#### To Cancel Self-Timer . . .

.... Before the recording begins, press the Recording Start/Stop Button to display "≡PAUSE≡", then set "INT. TIME" in the Menu Screen to "OFF".

## Animation

You can give stationary scenes or objects an illusion of movement. This function allows you to shoot a series of pictures, each slightly different, of the same object for a brief period of time.

### NOTE:

Before performing the following steps, make sure that:

- The Power Switch is set to "PRO."
- The camcorder is in the Record-Standby mode.
- The recording mode is set to "SP".

### 1 ACCESS MENU SCREEN

Press MENU.

### 2 SET RECORDING TIME

Rotate the Select Dial to move the highlight bar to "NEXT" in Menu Screen 1 and press it to display Menu Screen 2. Then, move the highlight bar to "REC TIME" and press it. The REC TIME Menu appears. Rotate the Select Dial to move the highlight bar to the desired time, then press it. The Menu Screen reappears with the highlight bar on "RETURN". Press the Select Dial again to close the Menu Screen.

### 3 START RECORDING

Press the Recording Start/Stop Button after focusing on the subject. The recording stops automatically after the selected period of time.

### 4 ASSEMBLE SERIES OF PICTURES

Repeat step 3 for the desired number of pictures.

### 5 RELEASE ANIMATION MODE

Set "REC TIME" in the Menu screen to "OFF".

## Time-Lapse

You can record sequentially at preset time spans. Leaving the camcorder aimed at a specific subject, you can record subtle changes over an extended period of time.

### NOTE:

Before performing the following steps, make sure that:

- The Power Switch is set to "PRO."
- The camcorder is in the Record-Standby mode.
- The recording mode is set to "SP".

### 1 ACCESS MENU SCREEN

Press MENU.

### 2 SET INTERVAL BETWEEN RECORDINGS

Rotate the Select Dial to move the highlight bar to "NEXT" in Menu Screen 1 and press it to display Menu Screen 2. Then, move the highlight bar to "INT. TIME" and press it. The INT. TIME Menu appears. Rotate the Select Dial to move the highlight bar to the desired time, then press it. The Menu Screen reappears.

### 3 SET RECORDING TIME

Rotate the Select Dial to move the highlight bar to "REC TIME", then press it. The REC TIME Menu appears. Rotate the Select Dial to move the highlight bar to the desired time, then press it. The Menu Screen reappears with the highlight bar on "RETURN". Press the Select Dial again to close the Menu Screen.

### 4 START TIME-LAPSE RECORDING

Press the Recording Start/Stop Button. Recording and intervals alternate automatically.

### 5 RELEASE TIME-LAPSE MODE

When "REC" is not displayed, press the Recording Start/Stop Button to display "≡PAUSE≡", then set "REC TIME" and "INT. TIME" in the Menu Screen to "OFF".

## NOTES (for Animation and Time-Lapse):

- For best results, make sure the camcorder is secured when shooting in Animation or Time-Lapse mode.
- Fade- or wipe-in/out cannot be performed during Animation or Time-Lapse shooting.
- Before performing other operations following Animation or Time-Lapse recording, make sure the Animation or Time-Lapse mode is deactivated.
- Self-Timer, Animation and Time-Lapse are canceled when the power is shut off or when the cassette is ejected.

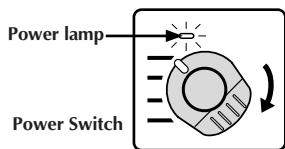
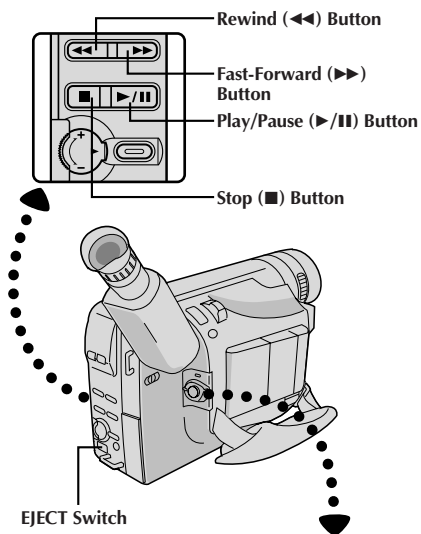

LCD Monitor in Retracted Position

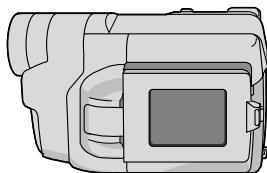

Battery pack remaining power indicator

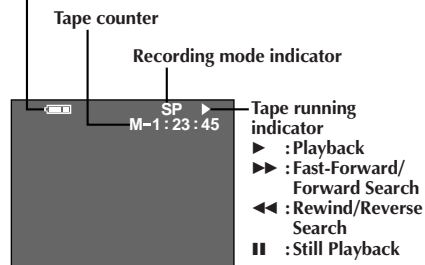

LCD monitor/viewfinder indications

**1 LOAD A CASSETTE**

First open the LCD monitor to an angle of over 60 degrees. Slide **EJECT** to open the cassette holder, then insert the cassette with the label facing out. Press the Close button to ensure the holder is closed and locked.

**2 SELECT MODE**

Make sure the LCD monitor is fully open, then set the Power Switch to "PLAY". The power lamp lights.

**3 PLAY BACK**

Press ▶/||. The playback picture appears.

**4 STOP PLAYBACK**

Press ■.

**Rewind or Fast-Forward the tape**

Press ◀◀ to rewind, or ▶▶ to fast-forward the tape during Stop mode.

**NOTES:**

- The camcorder shuts off automatically after about 5 minutes in Stop mode. To turn on again, set the Power Switch to "OFF", then to "PLAY".
- When the Power Switch is set to "PLAY" and the LCD monitor is opened at an angle of 60 degrees or more, the LCD monitor switches on and the viewfinder switches off automatically to save power.
- The playback picture can also be viewed in the viewfinder (with the LCD monitor shut) or on a connected TV (☞ pg. 40, 41). Camcorder operation is the same as described in this section.
- You can also view the playback picture on the LCD monitor with it flipped over and retracted.
- If a blank portion on the tape is played back, the screen may become black. This is not a malfunction.

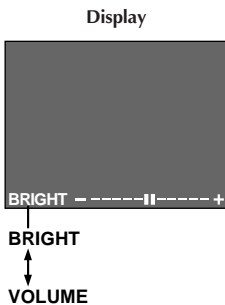
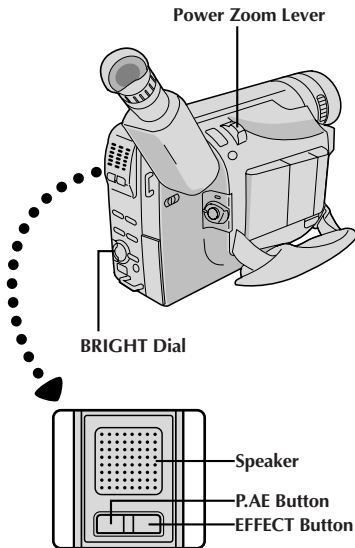

## Adjust the brightness of the LCD monitor

To brighten the image, turn the **BRIGHT** Dial towards “+”.  
To darken the image, turn the Dial towards “-”.

## Speaker Volume Control

You can adjust the speaker volume by pushing the Power Zoom Lever.

### 1 ADJUST VOLUME

*If you want to turn up the volume . . .*

.... push the Power Zoom Lever towards “T”.

*If you want to turn down the volume . . .*

.... push the Power Zoom Lever towards “W”.

## Tracking

This function can be used to eliminate noise bars that appear on-screen during playback. Initial setting is Auto Tracking. Manual Tracking is also available.

### 1 ACTIVATE MANUAL TRACKING

Press **P.AE** and **EFFECT** simultaneously. Then, press **P.AE** or **EFFECT** as many times as necessary until the noise bars disappear.

- To return to Auto Tracking, press **P.AE** and **EFFECT** simultaneously. “AT” blinks. When Auto Tracking finishes, the indication disappears.

## NOTES:

- When noise bars appear during playback, the camcorder enters the Auto Tracking mode and “AT” is displayed.
- Manual Tracking may not work with tapes recorded on other VCRs or camcorders.

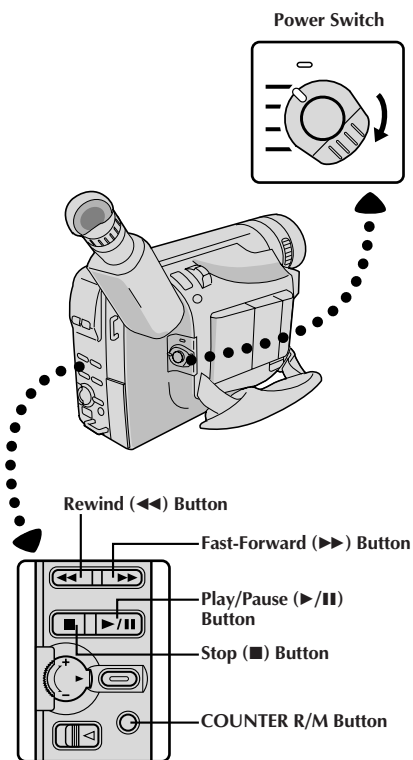
**FEATURE: Still Playback****PURPOSE:**

To pause during playback.

**OPERATION:**

- 1) Press ▶/|| during playback.
- 2) To resume normal playback, press ▶/|| again.

**NOTE:**

Noise bars appear and pictures may become monochrome during Still Playback. This is normal.

**FEATURE: Shuttle Search****PURPOSE:**

To allow high-speed search in either direction.

**OPERATION:**

- 1) Press ▶▶ to search forward or press ◀◀ to reverse during playback.
- 2) To resume normal playback, press ▶/||.

**NOTES:**

- During playback, press and hold ◀◀ or ▶▶. The search continues as long as you hold the button. Once you release it, normal playback resumes.
- Noise bars appear and pictures may become monochrome or darken during Shuttle Search. This is normal.

**FEATURE: Counter Memory Function****PURPOSE:**

To make it easier to locate a specific tape segment.

**OPERATION:**

- 1) Press COUNTER R/M and hold for more than 1 second. The counter resets to "0:00:00".
- 2) Press COUNTER R/M for less than 1 second. "M" appears.
- 3) After recording or playback, press ■, then ◀◀. The tape automatically stops at or close to 0:00:00.
- 4) Press ▶/|| to start playback.

**NOTES:**

- The counter memory functions in the Fast-Forward and Rewind modes.
- To disable the Counter Memory Function, press COUNTER R/M for less than 1 second so that "M" disappears.

## Cassette Adapter (optional)

Use this to play back a VHS-C video cassette recorded with this camcorder on a VHS VCR. It is fully compatible with any VHS video cassette recorder. The C-P7U (optional) adapter is battery powered and automatically performs tape loading and unloading.

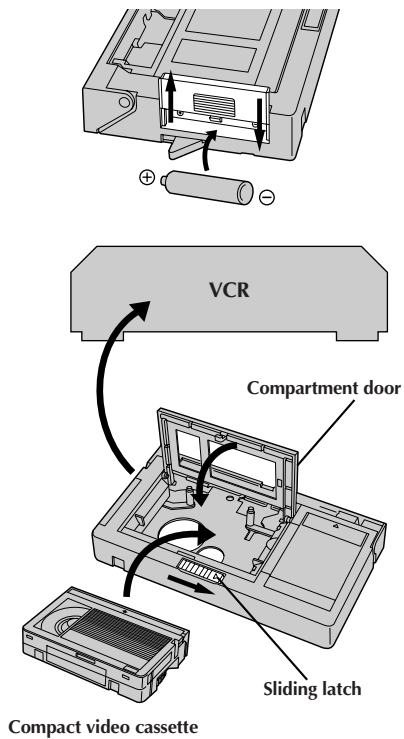

- 1 INSERT BATTERY**  
Slide the battery cover up to remove it, and install one "R6 (AA)" size battery as shown in the illustration on left, then reattach the cover.
- 2 INSERT CASSETTE IN ADAPTER**  
Slide the latch to open the adapter compartment door, then insert the cassette and close the compartment door.
- 3 PLAY BACK ON CONNECTED VCR**  
Load the cassette adapter into the VCR and play the tape back as you would any other.
- 4 REMOVE CASSETTE FROM ADAPTER**  
Slide the latch and the compartment door opens automatically. This may take around 10 seconds. Do not attempt to force the adapter open. Then, insert your finger in the hole on the underside of the adapter as shown in the illustration on left, and push up and remove the cassette.

### NOTES:

- During tape loading and unloading, do not touch the reels for safety and tape protection.
- During special-effect playback (slow motion, still frame, etc.), the picture may vibrate or noise bars may appear on the screen.
- To record on a VCR using a compact cassette and the adapter, cover the adapter's recording safety hole with adhesive tape.

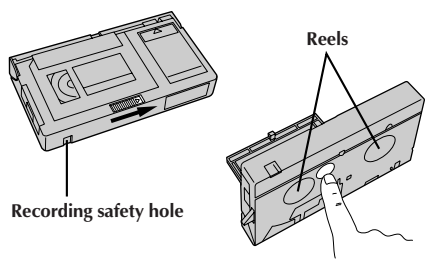

These are some basic types of connections. When making connections, refer also to your VCR and TV instruction manuals.

## Basic Connections

Use the provided Audio/Video cable.

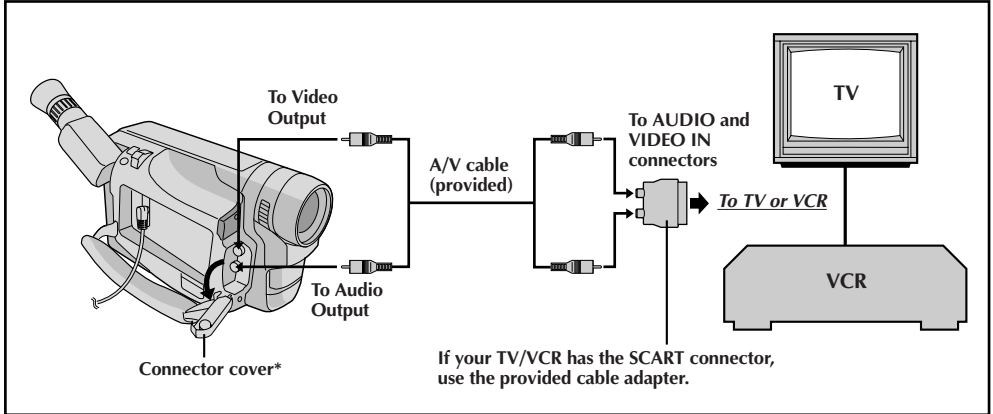

## Connection For Tape Dubbing

Use the provided Audio/Video cable.

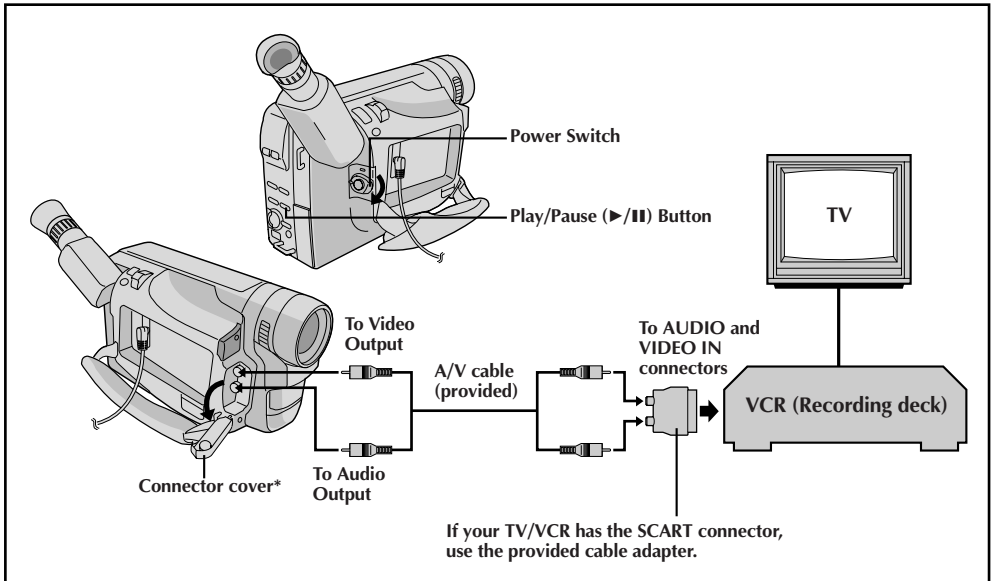

\* When connecting the cables, open this cover.



## Basic Connections

- 1 CONFIRM POWER-OFF STATUS**  
Make sure the camcorder's power is off.
- 2 CONNECT CAMCORDER TO TV OR VCR**  
Pull out the connector cover and open it.  
Connect as shown in the illustration (☞ pg. 40).  
*If using a VCR . . . go to step 3.*  
*If not . . . go to step 4.*
- 3 CONNECT VCR OUTPUT TO TV INPUT**  
Refer to your VCR's instruction manual.
- 4 SUPPLY POWER**  
Turn on the camcorder, the VCR and the TV.
- 5 SELECT MODE**  
Set the VCR to its AUX input mode, and set the TV to its VIDEO mode.

### NOTES:

- ***It is recommended to use the AC Power Adapter/Charger as the power supply instead of the battery pack (☞ pg. 7).***
- *To monitor the picture and sound from the camcorder without inserting a tape, set the camcorder's Power Switch to "CAMERA" ("AUTO" or "PRO."), then set your TV to the appropriate input mode.*
- *Make sure you adjust the TV sound volume to its minimum level to avoid a sudden burst of sound when the camcorder is turned on.*
- *If you have a TV or speakers that are not specially shielded, do not place the speakers adjacent to the TV as interference will occur in the camcorder playback picture.*

## Tape Dubbing

- 1 CONNECT EQUIPMENT**  
Following the illustration on pg. 40, connect the camcorder and the VCR.
- 2 PREPARE FOR DUBBING**  
Set the camcorder's Power Switch to "PLAY", turn on the VCR's power, and insert the appropriate cassettes in the camcorder and the VCR.
- 3 SELECT VCR MODE**  
Engage the VCR's AUX and Record-Pause modes.
- 4 FIND EDIT-IN POINT**  
Engage the camcorder's Play mode to find a spot just before the edit-in point. Once it is reached, press ►/II on the camcorder.
- 5 START EDITING**  
Press ►/II on the camcorder and engage the VCR's Record mode.
- 6 STOP EDITING TEMPORARILY**  
Engage the VCR's Record-Pause mode and press ►/II on the camcorder.
- 7 EDIT MORE SEGMENTS**  
Repeat steps 4 through 6 for additional editing, then stop the VCR and camcorder when finished.

The Full-Function Remote Control Unit can operate this camcorder from a distance as well as the basic operations (Playback, Stop, Pause, Fast-Forward and Rewind) of your VCR. The RM-V700U remote control unit (optional) makes additional recording functions possible.

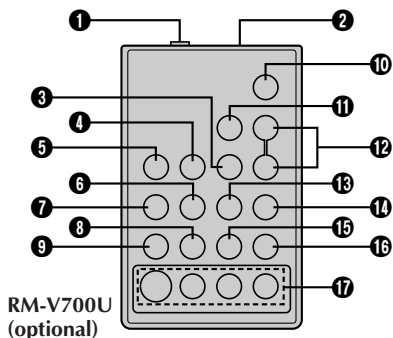
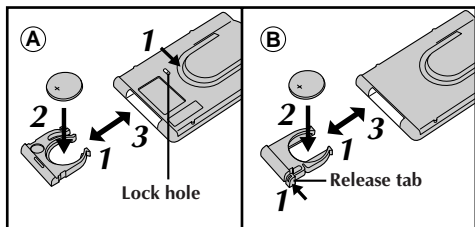

RM-V700U  
(optional)

## Installing The Battery

The remote control uses one lithium battery (CR2025).

### 1

#### PULL OUT BATTERY HOLDER

Pull out the battery holder according to the type of remote control unit you have.

Ⓐ : Pull out the battery holder while sliding the lock hole.

Ⓑ : Pinch the release tab and pull out the battery holder.

### 2

#### INSERT BATTERY IN HOLDER

Insert the battery in the holder, and be sure to have the "+" mark visible.

### 3

#### RE-INSERT HOLDER

Slide the holder back in until you hear a click.

- Read the caution concerning lithium batteries (☞ pg. 2).

Buttons	Functions	
	With the camcorder's Power Switch set to "CAMERA", "AUTO" or "PRO".	With the camcorder's Power Switch set to "PLAY".
① PAUSE IN Connector	—	☞ pg. 45
② Infrared beam transmitting window	Transmits the beam signal.	
③ MBR SET Button	—	☞ pg. 44
④ INT. TIME Button SELF TIMER Button	Self-Timer, Time-Lapse (☞ pg. 43)	—
⑤ REC TIME Button ANIM. Button	Animation, Time-Lapse (☞ pg. 43)	—
⑥ FF Button	Retake (forward) (☞ pg. 19)	Fast-Forward, Forward Shuttle Search (☞ pg. 36, 38)
⑦ REW Button	Retake (rewind), Quick Review (☞ pg. 19)	Rewind, Reverse Shuttle Search (☞ pg. 36, 38)
⑧ PAUSE Button	—	Pause (☞ pg. 38)
⑨ PLAY Button	—	Playback start (☞ pg. 36)
⑩ START/STOP Button	Functions same as the Recording Start/Stop button on the camcorder.	
⑪ VISS Button	Ineffective	
⑫ ZOOM (T/W) Buttons	Zoom in/out (☞ pg. 18)	—
⑬ VCR CTL Button	—	☞ pg. 44
⑭ A.DUB Button	—	Audio dubbing (☞ pg. 49)
⑮ STOP Button	—	Stop (☞ pg. 36)
⑯ INSERT Button	—	Insert Editing (☞ pg. 48)
⑰ R.A.EDIT Buttons	—	☞ pg. 46

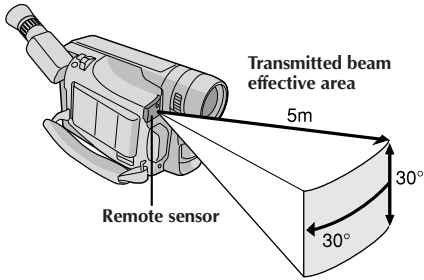

When using the remote control, be sure to point it at the remote sensor. The illustration shows the approximate transmitted beam effective area for indoor use.

The transmitted beam may not be effective or may cause incorrect operation outdoors or when the remote sensor is directly exposed to sunlight or powerful lighting.

#### Interval timer indicator

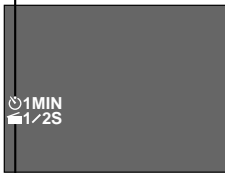

#### Rec time indicator

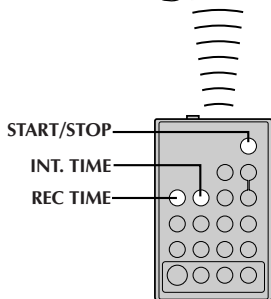
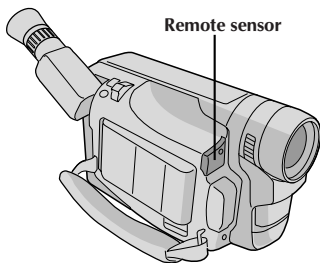

RM-V700U  
(optional)

## FEATURE: Self-Timer, Animation and Time-Lapse

### PURPOSE:

The remote control lets you set/release Interval Timer and Rec Time functions without using the Menu Screen.

### OPERATION:

#### Self-Timer

##### 1) Set

Instead of performing steps **1** through **4** on pg. 34 ("Self-Timer"), press **INT. TIME** on the remote control. Each time **INT. TIME** is pressed, the Interval Timer indicator appears, changing in the following order: 15S, 30S, 1MIN, 5MIN and No indication (off).

##### 2) Release

Instead of setting "INT. TIME" to "OFF" in the Menu, press **INT. TIME** on the remote control until the Interval Timer indicator disappears.

#### Animation

##### 1) Set

Instead of performing steps **1** and **2** on pg. 35 ("Animation"), press **REC TIME** on the remote control. Each time **REC TIME** is pressed, the Rec Time indicator appears, changing in the following order: 1/4S, 1/2S, 1S, 5S and No indication (off).

##### 2) Release

Instead of using the Menu in step **5** on pg. 35, press **REC TIME** on the remote control until the Rec Time indicator disappears.

#### Time-Lapse

##### 1) Set

Instead of performing steps **1** through **3** on pg. 35 ("Time-Lapse"), press **INT. TIME** and **REC TIME** on the remote control. Each time **INT. TIME** is pressed, the Interval Timer indicator appears, changing in the following order: 15S, 30S, 1MIN, 5MIN and No indication (off). Each time **REC TIME** is pressed, the Rec Time indicator appears, changing in the following order: 1/4S, 1/2S, 1S, 5S and No indication (off).

##### 2) Release

Instead of using the Menu in step **5** on pg. 35, press **INT. TIME** and **REC TIME** on the remote control until the indicators disappear.

### NOTE:

Also refer to pgs. 34 and 35.

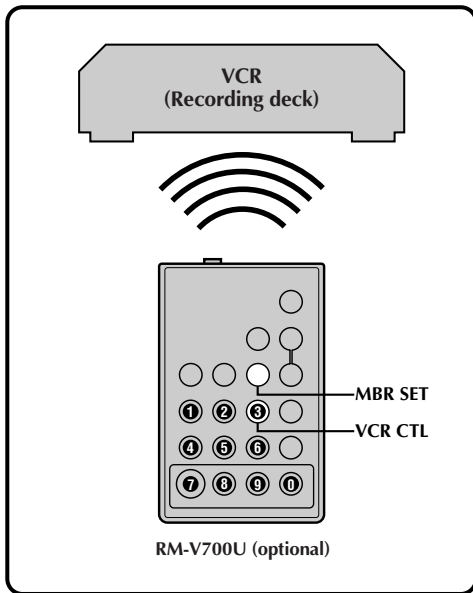

## Random Assemble Editing [R.A.Edit]

Create edited videos easily using your camcorder as the source player. You can select up to 8 “cuts” for automatic editing, in any order you like. R.A.Edit is more easily performed when the RM-V700U MBR (Multi-Brand Remote, see pg. 42) is set to operate with your brand of VCR (see VCR CODE LIST), but can also be performed by operating the VCR manually.

Before operation, make sure the lithium battery is installed in the remote control RM-V700U (see pg. 42).

### SET REMOTE/VCR CODE

#### 1 SET REMOTE TO OPERATE VCR

Turn off the power to the VCR and point the remote towards the VCR's infrared sensor. Then, referring to the VCR CODE LIST on the left, press and hold **MBR SET**, and press button (A) and then (B).

- The code is automatically set once you release **MBR SET**, and the VCR's power comes on.

#### 2 OPERATE VCR

Make sure the VCR's power is on. Then, while holding **VCR CTL**, press the button on the remote for the desired function. The functions the remote can control are PLAY, STOP, PAUSE, FF, REW and VCR REC STBY (you do not need to press **VCR CTL** for this one).

*You are now ready to try Random Assemble Editing.*

### VCR CODE LIST

VCR BRAND NAME	BUTTONS (A) (B)	VCR BRAND NAME	BUTTONS (A) (B)
AKAI	6 2 6 4 7 7	PHILIPS	1 9 9 5 1 1 9 4 9 1
BLAUPUNKT	1 3		9 6 1 2 3 3 7 2
FERGUSON	9 7 9 8 3 2	SANYO	3 6 3 5
GRUNDIG	1 4 3 4	SELECO, REX	9 1 9 6
HITACHI	6 6 6 3	SHARP	1 5 1 0
JVC A B C	9 1 9 6 9 3	SONY	6 5 6 0 3 9 3 1
MITSUBISHI	6 7 6 8	THOMSON, TELEFUNKEN, SABA, NORDMENDE	9 1 9 6 9 7 3 2
NEC	3 7 3 8	TOSHIBA	6 9 6 1
PANASONIC	1 3 1 7 1 1 9 4 1 8		

## IMPORTANT

Although the MBR is compatible with JVC VCRs and those of many other makers, it may not work with yours or may offer limited functions.

## NOTES:

- If the VCR's power does not come on in step 1, try another code from the VCR CODE LIST.
- Some brands of VCR do not come on automatically. In this case, turn the power on manually and try step 2.
- If the remote control is not able to control the VCR, use the controls on the VCR.
- When the remote control's battery runs out, the VCR brand you have set will be erased. In that case, replace the old battery with a new one and reset the VCR brand.

## MAKE CONNECTIONS

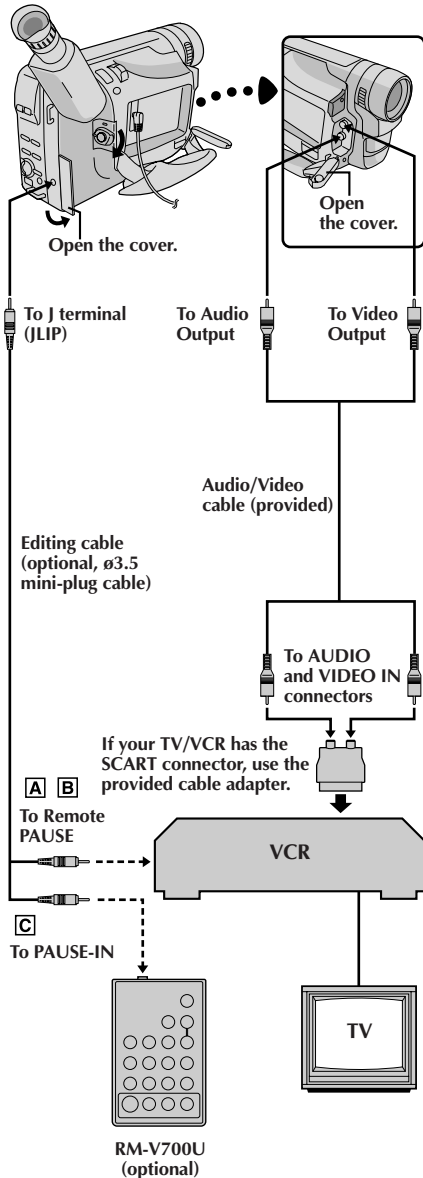
**1** CONNECT TO . . .**A** JVC VCR EQUIPPED WITH REMOTE PAUSE TERMINAL

Connect the editing cable to the Remote PAUSE terminal.

**B** JVC VCR NOT EQUIPPED WITH REMOTE PAUSE TERMINAL BUT EQUIPPED WITH R.A. EDIT CONNECTOR

Connect the editing cable to the R.A.EDIT connector.

**C** VCR OTHER THAN TYPE **A** OR **B**

Connect the editing cable to the RM-V700U's PAUSE-IN connector.

**2** PREPARE CAMCORDER

Insert a recorded tape into the camcorder, and set the Power Switch to "PLAY".

**3** PREPARE VCR

Turn the VCR power on, insert a recordable tape and engage the AUX mode (refer to the VCR's instructions).

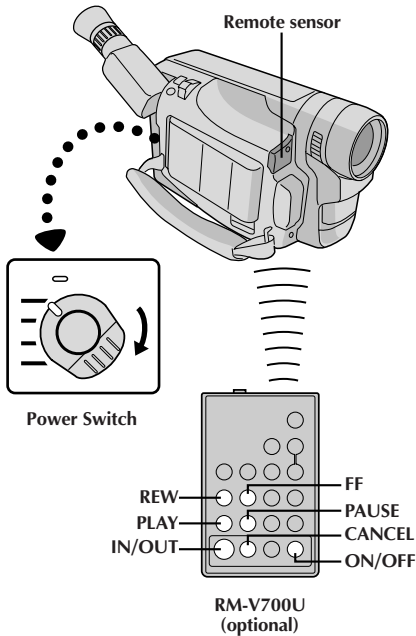

	IN	OUT
1	0:00:25	--:--:--
2		
3		
4		
5		
6		
7		
8		
COUNTER	0:00:25	
TOTAL	0:00:00	

	IN	OUT
1	0:00:25	0:01:05
2	0:03:18	0:03:31
3	0:02:33	0:02:53
4	0:04:11	--:--:--
5		
6		
7		
8		
COUNTER	0:04:11	
TOTAL	0:01:13	

## SELECT SCENES

### 4 START SOURCE PLAYBACK

Point the remote control at the camcorder's remote sensor. Press **PLAY**, then press **ON/OFF** on the remote control.

- The R.A. Edit counter display appears.

### 5 REGISTER BEGINNING OF SCENE

Press **REW** or **FF** to locate the beginning of the scene you want, then press **IN/OUT** to register that point.

- The data appears under "IN" on the display.

### 6 REGISTER END OF SCENE

Press **REW** or **FF** to locate the end of the scene and press **IN/OUT** to register it.

- The data appears under "OUT" on the display.
- The total time of the registered scene(s) is displayed at the bottom of the screen.

### 7 REGISTER ADDITIONAL SCENES

Repeat steps 5 and 6 for each additional scene (as many as 8).

### 8 MAKE CORRECTIONS (IF NECESSARY)

Press **CANCEL** during steps 5 and 6 to erase the most recently registered point.

## NOTES:

- There must be at least one second between an in-point and its corresponding out-point.
- To ensure correct operation, there should be at least 15 seconds between an out-point and the next in-point.
- Blank portions of a tape cannot be registered as in-points or out-points.
- If it takes more than 5 minutes to search for an in-point, the VCR's Record-Pause mode is cancelled and editing does not take place.
- Pressing **ON/OFF** clears all in- and out-points from memory.
- Leave a small margin for error around each in-point to ensure the scene is recorded in its entirety.
- Turning off the camcorder's power erases all registered in- and out-points.

Original tape (camcorder)

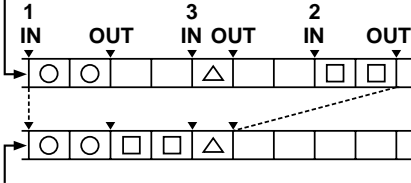

Edited tape (VCR)

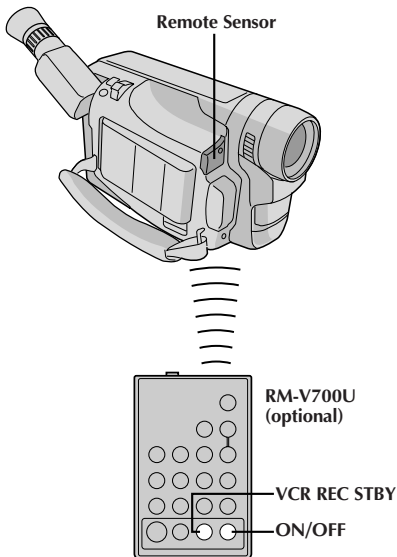
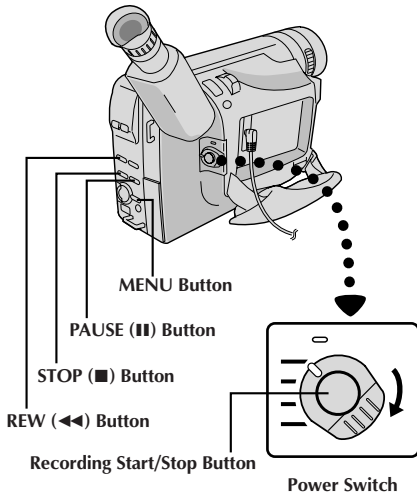

## AUTOMATIC EDITING TO VCR

**9 PREPARE SOURCE TAPE**

Rewind the tape in the camcorder to the beginning of the scene you want to edit and press **PAUSE**.

**10 ENGAGE VCR'S RECORD-PAUSE MODE**

Point the remote control towards the VCR's infrared sensor and press **VCR REC STBY**, or manually engage the VCR's Record-Pause mode.

**11 BEGIN AUTOMATIC EDITING**

Press **MENU** on the camcorder, and the previously selected scenes are copied to the VCR in the specified order.

While editing, the R.A. Edit counter of the scene which is being copied is shown with a blinking highlight.

- Pressing **START/STOP** on the remote control does not start editing.

**12 END AUTOMATIC EDITING**

When all selected scenes have been copied, the camcorder and VCR enter the Still or Pause mode. Press **STOP** on both units. To make the R.A. Edit counter display disappear, press **ON/OFF**.

- When finished editing, be sure to disconnect the editing cable and the audio/video cable.

**NOTES:**

- If you performed step 1  on page 45 ("MAKE CONNECTIONS"), keep the remote control pointed at the VCR during editing.
- The on-screen display only appears while the camcorder searches for each scene.
- There may be noise at in- or out-points on the edited tape with certain VCRs.

Power Switch

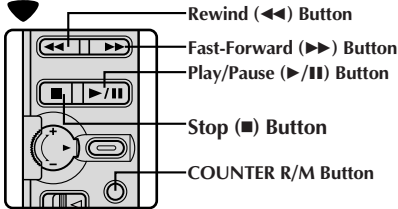
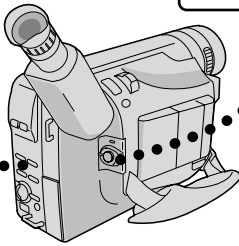
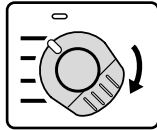

Display

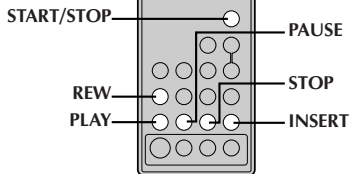
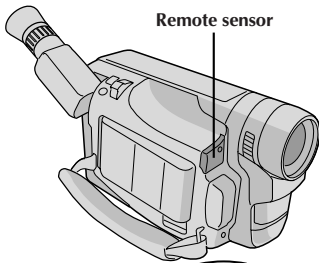
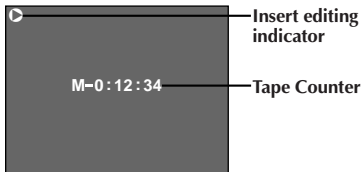
RM-V700U  
(optional)

## Insert Editing

You can record a new scene onto a previously recorded tape, replacing a section of the original recording with minimal picture distortion at the in- and out-points. The original audio remains unchanged.

### NOTE:

Use the RM-V700U remote control unit to perform this procedure.

- 1 SELECT OPERATION MODE**  
Set the Power Switch to "PLAY".
- 2 FIND EDIT-OUT POINT**  
Play back the tape, locate the Edit-Out point and press **PAUSE** on the camcorder or the remote control.
- 3 RESET COUNTER**  
Press and hold **COUNTER R/M** on the camcorder for more than 1 second to reset the tape counter, then press it again for less than 1 second so that "M" appears.
- 4 FIND EDIT-IN POINT**  
Press **REW** to go a little beyond the beginning of the scene you want to replace, press **PLAY** to view the recorded tape, and press **PAUSE** exactly at the Edit-In point where the new scene should start.
- 5 ENGAGE INSERT EDITING MODE**  
Press and hold **INSERT**, and without releasing **INSERT**, press and release **PAUSE**. The Insert Editing mode is engaged. When the scene the camcorder is aimed at appears on the screen, go to the next step.
- 6 BEGIN INSERT EDITING**  
Press **START/STOP**. When the counter reaches "0:00:00", editing stops automatically and the camcorder enters the Insert-Pause mode.
- 7 END INSERT EDITING**  
Press **STOP**.

### NOTES:

- During Insert Editing, the original audio will be heard from the speaker.
- After step 5, Retake (⏮ pg. 19) can be performed.
- The tape may stop slightly before or after the designated end point, and noise bars may appear. Neither indicates a defect in the unit.
- Only the video signal is recorded in the Insert Editing mode.



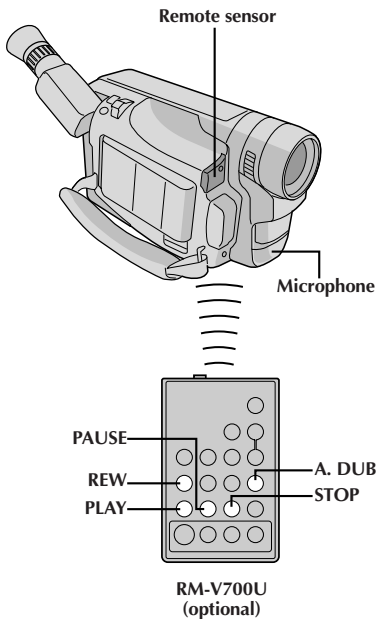
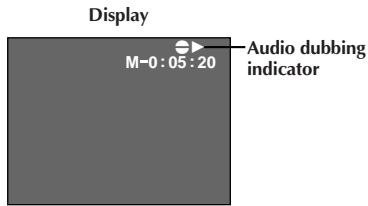

## Audio Dubbing

You can record a new soundtrack on a prerecorded tape. The existing original sound is erased and replaced by the sound from the built-in microphone.

**Perform steps 1, 2 and 3 of the Insert Editing procedure (pg. 48) before continuing.**

### NOTE:

Use the RM-V700U remote control unit to perform the following procedures.

#### 1 FIND EDIT-IN POINT

Press **REW** to go a little beyond the beginning of the scene onto which you want to dub the new audio, press **PLAY** to view the recorded tape, then press **PAUSE** at exactly the point where dubbing should start.

#### 2 ENGAGE AUDIO DUB-STANDBY MODE

Press and hold **A. DUB**, and without releasing **A. DUB**, press and release **PAUSE**.

#### 3 BEGIN AUDIO DUBBING

Press **PLAY**. When the counter reaches "0:00:00", Audio Dubbing stops automatically and the camcorder enters the Audio Dub-Standby mode.

#### 4 END AUDIO DUBBING

Press **STOP**.

### NOTES:

- Do not press **FF** or **REW** during Audio Dub-Standby, or the edit points will not be accurate.
- If the microphone is too close to the TV, or if the TV's volume is too high, whistling or howling may occur.

### NOTES (for Insert Editing and Audio Dubbing):

- Insert Editing and Audio Dubbing may not work correctly if the tape contains blank segments.
- To edit/dub onto a tape, make sure the Erase Protection tab is in the position that allows recording. If not, slide the tab. Some cassettes have removable tabs. If the tab has been removed, cover the hole with adhesive tape.
- Do not press **STOP** during Insert Editing or Audio Dubbing, or the edit points will not be accurate.
- During Insert Editing and Audio Dubbing, when Insert-Pause or Audio Dub-Standby is engaged, the counter may go slightly past "0:00:00". Recording, however, stops at exactly 0:00:00.

LENS COVER Open/Close Ring

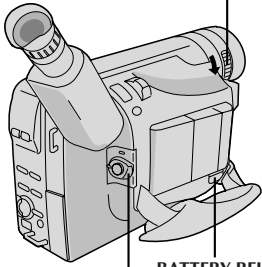

BATTERY RELEASE

Set to "OFF".

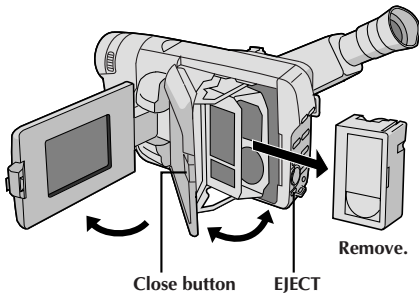

Close button

EJECT

Remove.

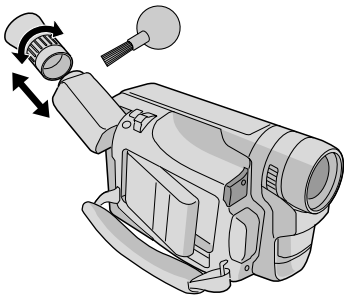

## After Use

- 1** Set the Power Switch to "OFF" to turn off the camcorder.
- 2** Open the LCD monitor to an angle of over 60 degrees. Slide **EJECT** to open the cassette holder, then remove the cassette.
- 3** Close and lock the cassette holder by pressing the Close button.
- 4** Close and lock the LCD monitor.
- 5** Slide **BATTERY RELEASE** to remove the battery pack.
- 6** Turn the **LENS COVER Open/Close Ring** to close the lens cover.

## Cleaning The Camcorder

- 1 CLEAN EXTERIOR**  
Wipe gently with a soft cloth.
  - Put cloth in diluted mild soap and wring it well to wipe off heavy dirt, then wipe again with a dry cloth.
- 2 CLEAN LCD MONITOR**  
Open the LCD monitor and wipe it gently with a soft cloth. Be careful not to damage the monitor. Close the LCD monitor.
- 3 CLEAN LENS**  
Blow it with a blower brush, then wipe it gently with lens cleaning paper.
- 4 REMOVE EYEPIECE**  
Turn the eyepiece counterclockwise and pull it out.
- 5 CLEAN VIEWFINDER**  
Remove dust using a blower brush.
- 6 RE-ATTACH EYEPIECE**  
Re-attach the eyepiece and turn it clockwise.

## NOTES:

- Avoid using strong cleaning agents such as benzine or alcohol.
- Cleaning should be done only after the battery pack has been removed or other power units have been disconnected.
- Mould may form if the lens is left dirty.
- When using a cleaner or chemically treated cloth, refer to the cautions that came with it.
- When removing the eyepiece, be sure to hold the viewfinder securely.

If, after following the steps in the chart below, the problem still exists, please consult your JVC dealer.

The camcorder is a microcomputer-controlled device. External noise and interference (from a TV, a radio, etc.) might prevent it from functioning properly. In such cases, first disconnect its power supply unit (battery pack, AC Power Adapter/Battery Charger, etc.) and clock battery; and then re-connect it and proceed as usual from the beginning.

SYMPTOM	POSSIBLE CAUSE(S)
<b>POWER</b>	
No power is supplied.	<ul style="list-style-type: none"> <li>● The battery pack has not been attached correctly (☞ pg. 6).</li> <li>● The battery pack is not charged (☞ pg. 6).</li> <li>● The power supply has not been correctly connected (☞ pg. 7).</li> </ul>
The power suddenly goes off and does not come back on by itself.	<ul style="list-style-type: none"> <li>● The battery pack has completely discharged.</li> <li>● Remove the cassette and disconnect the power source, then after a few minutes, try turning the power back on. If it still does not come on, consult your nearest JVC dealer.</li> </ul>
<b>RECORDING</b>	
Recording cannot be performed.	<ul style="list-style-type: none"> <li>● Make sure the Erase Protection tab is in the position that allows recording. If not, slide the tab. Some cassettes have removable tabs. If the tab has been removed, cover the hole with adhesive tape.</li> </ul>
Recording does not start.	<ul style="list-style-type: none"> <li>● The camcorder Power Switch has not been set to "CAMERA" ("AUTO" or "PRO.".) (☞ pg. 14).</li> </ul>
Animation or Time-Lapse is not available.	<ul style="list-style-type: none"> <li>● Before recording in the Animation mode at the very beginning of a tape, set the camcorder to the Recording mode for about 5 seconds, so that the tape runs smoothly. Using the Fade-in function at this point is a good way to begin an animated programme (☞ pg. 35, 43).</li> </ul>
<b>PLAYBACK</b>	
The tape is running, but there is no playback picture.	<ul style="list-style-type: none"> <li>● The TV has not been set to its VIDEO mode or channel.</li> <li>● If A/V connection is used, the TV's VIDEO/TV Switch has not been set to VIDEO.</li> </ul>
Playback picture is blurred or interrupted.	<ul style="list-style-type: none"> <li>● The video heads are dirty or worn out. Consult your nearest JVC dealer for head cleaning or replacement.</li> </ul>
The counter indication is blurred during Still playback.	<ul style="list-style-type: none"> <li>● This is normal.</li> </ul>
<b>TAPE TRANSPORT</b>	
The tape stops during fast-forward or rewind.	<ul style="list-style-type: none"> <li>● The Counter Memory Function has been activated (☞ pg. 38).</li> </ul>
Rewinding or fast-forwarding cannot be performed.	<ul style="list-style-type: none"> <li>● The tape is already fully wound on one reel or the other.</li> </ul>



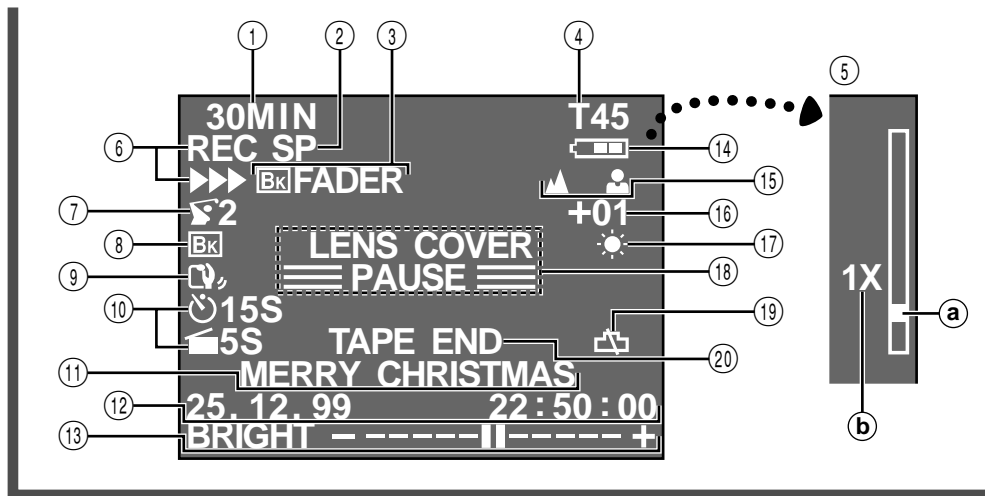



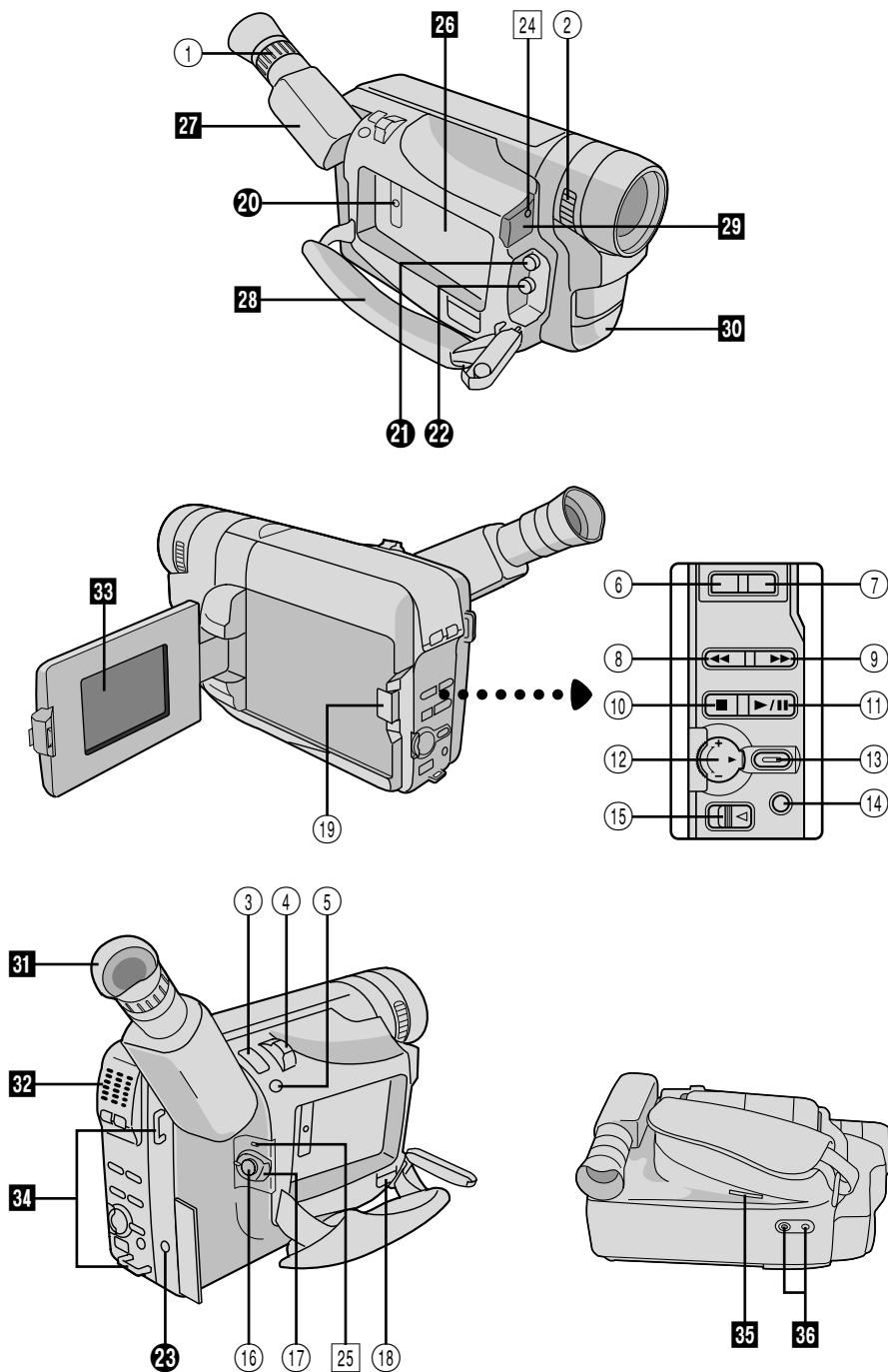

















SYMPTOM	POSSIBLE CAUSE(S)
<b>OTHER</b>	
During recording, the indications do not appear.	<ul style="list-style-type: none"> <li>● Press <b>DISPLAY</b> for longer than 1 second to make the indications appear (☞ pg. 15).</li> </ul>
The tape will not eject.	<ul style="list-style-type: none"> <li>● The battery pack is running low.</li> <li>● If the LCD monitor is not open over 60 degrees, the <b>EJECT</b> Switch does not function.</li> </ul>
Some functions are not available.	<ul style="list-style-type: none"> <li>● The Power Switch is set to "AUTO".</li> <li>● Certain combinations of modes or effects are not possible to use.</li> </ul>
Vertical white lines appear when shooting a very bright object.	<ul style="list-style-type: none"> <li>● This sometimes occurs when the contrast between the background and the object is great. It is not a defect of the camcorder.</li> </ul>
Bright, crystal-shaped spots appear in the LCD monitor and the viewfinder.	<ul style="list-style-type: none"> <li>● Sunlight is directly entering the lens. This is not a defect of the camcorder.</li> </ul>
The rear of the LCD monitor is hot.	<ul style="list-style-type: none"> <li>● The light used to illuminate the LCD monitor causes it to be hot. Close the LCD monitor to turn it off or set the Power Switch to "OFF", and let the unit cool down.</li> </ul>
Coloured bright spots appear all over the LCD monitor or the viewfinder.	<ul style="list-style-type: none"> <li>● The LCD monitor and the viewfinder are made with high-precision technology. However, black spots or bright spots of light (red, green or blue) may appear constantly on the LCD monitor or in the viewfinder. These spots are not recorded on the tape. This is not due to any defect of the unit. (Effective dots: more than 99.99 %.)</li> </ul>
The indicators and the picture colour on the LCD monitor are not clear.	<ul style="list-style-type: none"> <li>● This may occur when the surface or the edge of the LCD monitor is pressed.</li> </ul>
The LCD monitor, the viewfinder and the lens have become dirty (ex. fingerprints).	<ul style="list-style-type: none"> <li>● Wipe them gently with a soft cloth. Gently wipe in a semicircular motion, as wiping strongly spreads the stain and it won't come out easily.</li> </ul>
An error number (i.e. E03) appears.	<ul style="list-style-type: none"> <li>● Turn the camcorder's power off, then disconnect the power source. After a few minutes, try turning the power on again. If the error number still appears in the viewfinder, consult your nearest JVC dealer.</li> </ul>
The image is out of focus.	<ul style="list-style-type: none"> <li>● The dioptre needs to be adjusted (☞ pg. 12).</li> <li>● The scene being shot is adversely affecting the operation of Auto Focus (☞ pg. 30).</li> </ul>
The picture is blurred in the Quick Review or Retake mode.	<ul style="list-style-type: none"> <li>● This is normal while recording in the LP mode. Some noise may be present while recording in the SP mode (☞ pg. 10).</li> </ul>
The date and time displays disappear.	<ul style="list-style-type: none"> <li>● If you remove the power source from the camcorder while the power is on, all settings and selections are erased. Make sure to turn the camcorder's power off before disconnecting the power source.</li> </ul>
The wrong date and time are displayed/recorded.	<ul style="list-style-type: none"> <li>● If you have not performed Date/Time Setting (☞ pg. 9), the date and time are not displayed/recorded correctly. Be sure that Date/Time setting is carried out.</li> </ul>
Even though the lens cover is open, the Lens Cover Warning indicator blinks.	<ul style="list-style-type: none"> <li>● The Lens Cover Warning indicator may blink when the camcorder is used in dark areas, regardless of the position of the lens cover.</li> </ul>







- ① Cassette Warning/  
Tape Remaining Time ..... pg. 15  
When no cassette is inserted: the cassette () warning blinks.  
When the Erase Protection tab is not in the position that allows recording: the cassette () warning lights. Otherwise, the tape remaining time is displayed and the tape remaining time warning blinks when the tape is about to reach its end.  
When the Power Switch is set to "PLAY" and a tape is loaded: the cassette () mark is displayed regardless of the Erase Protection tab's position.
- ② Recording Mode (SP/LP) Indicator ..... pg. 10
- ③, ⑦ Programme AE Indicator ..... pg. 22  
Displayed at ③ for approx. 2 seconds when Programme AE with special effects is switched from one mode to another by pressing **P.AE**, then only the indicator remains at ⑦.
- ③, ⑧ Fade/Wipe-Standby Indicator ..... pg. 21  
Displayed at ③ for approx. 2 seconds when the Fade/Wipe is switched from one effect to another by pressing **EFFECT**, then only the indicator remains at ⑧.
- ④ Tape Length Indicator ..... pg. 10
- ⑤ Zoom Indicator Bar ..... pg. 18  
  - Ⓐ Zoom Level Indicator
  - Ⓑ Approximate Zoom Ratio
- ⑥ Recording Indicator ..... pg. 14
- ⑨ Picture Stabilizer Indicator ..... pg. 20
- ⑩ • Interval Timer/Recording Time Indicator ..... pg. 34, 43  
  - 5 Sec. Rec Mode Indicator ..... pg. 20
- ⑪ Instant Title Display ..... pg. 25
- ⑫ Date/Time Display ..... pg. 24
- ⑬ • Bright Level Indicator ..... pg. 37  
  - Speaker Volume Indicator ..... pg. 37
- ⑭ Battery Pack Remaining Power Indicator  
Changes as follows according to the battery pack's remaining power level:  
"→→→". When the power is almost gone, the indicator "" blinks (battery power warning), then the unit shuts off. Replace the battery pack with a fully charged one.  
**Note:** The symbol containing 3 darkened squares — — does not necessarily mean that the battery pack is fully charged.
- ⑮ Focus Indicator ..... pg. 31
- ⑯ Exposure Control Level Counter ..... pg. 29
- ⑰ White Balance Mode Indicator ..... pg. 32
- ⑱ • Record-Standby Mode Indicator ..... pg. 14  
  - Lens Cover Warning:  
LENS COVER ..... pg. 15
- ⑲ Clock Battery Warning  
Blinks for approx. 10 seconds when the power is turned on. This display also blinks when the clock (lithium) battery is either not installed or has discharged. Install or replace the old battery with a new one ( pg. 8).
- ⑳ • Tape End Display: TAPE END ..... pg. 15  
Appears when the end of the tape is reached during playback, recording or fast-forward.  
  - Condensation Warning:
  - When this indication appears, all functions except tape eject and power on/off are disabled. Remove the tape, turn the unit off (without removing the power source) for a few hours, and when you turn it on again the indication should disappear.
  - Head Clog Warning:
  - Appears if dirty heads are detected during recording. In such a case, use the optional Cleaning Cassette. If, after using it, the problems still exist, consult your nearest JVC dealer.





## Controls

- ① Dioptre Adjustment Control .....  pg. 12
- ② Lens Cover Open/Close Ring [LENS COVER] .....  pg. 14
- ③ 5-Second Recording Button [5 SEC. REC] .....  pg. 20
- ④ • Power Zoom Lever [T/W] .....  pg. 18
  - Speaker Volume Control [VOL.] .....  pg. 37
- ⑤ Picture Stabilizer Button [P.STABILIZER] .....  pg. 20
- ⑥ Programme AE Button [P.AE] .....  pg. 22
- ⑦ Fade/Wipe Button [EFFECT] .....  pg. 21
- ⑧ • Rewind Button [REW] .....  pg. 36
  - Retake Rewind Button [RETAKE R] .....  pg. 19
  - Quick Review Button [Q.R] .....  pg. 19
- ⑨ • Fast-Forward Button [FF] .....  pg. 36
  - Retake Forward Button [RETAKE F] .....  pg. 19
- ⑩ Stop Button [STOP] .....  pg. 36
- ⑪ Play/Pause Button [PLAY/PAUSE] .....  pg. 36
- ⑫ • Select Dial [PUSH] .....  pg. 9, 26
  - Bright Dial [BRIGHT] .....  pg. 17
- ⑬ MENU/DISPLAY Button .....  pg. 15, 26
- ⑭ • Counter Reset/Memory Button [COUNTER R/M] .....  pg. 38
  - Recording Mode Button [SP/LP] .....  pg. 10
- ⑮ EJECT Switch .....  pg. 11
- ⑯ Recording Start/Stop Button .....  pg. 14
- ⑰ Power Switch .....  pg. 14, 36
- ⑱ Battery Release Switch [BATTERY RELEASE] .....  pg. 6
- ⑲ Close Button .....  pg. 11











## Connectors

- ⑳ DC IN Jack .....  pg. 7
- The connectors ㉑ to ㉓ are located beneath the cover.
- ㉑ Video Output Connector .....  pg. 40
  - ㉒ Audio Output Connector .....  pg. 40
  - ㉓ J Terminal [JLIP (Joint Level Interface Protocol) Connector]
    - Connect the editing cable when performing Random Assemble Editing ( pg. 44–47).
    - It is used to connect the camcorder to a device such as a personal computer. For further details consult your nearest JVC dealer.
    - JLIP-controlled editing from camcorder to VCR is not possible if the VCR is not equipped with a J terminal.







## Indicators

- ㉔ Tally Lamp .....  pg. 14
- ㉕ Power Lamp .....  pg. 14

## Other Parts

- ㉖ Battery Pack Mount .....  pg. 6
- ㉗ Viewfinder .....  pg. 12
- ㉘ Grip Strap .....  pg. 12
- ㉙ • Camera sensor
  - Be careful not to cover this area; a sensor necessary for shooting is built-in here.
  - Remote Sensor .....  pg. 43
- ㉚ Microphone .....  pg. 49
- ㉛ Eyepiece .....  pg. 50
- ㉜ Speaker .....  pg. 37
- ㉝ LCD Monitor .....  pg. 17
- ㉞ Shoulder Strap Eyelets .....  pg. 13
- ㉟ Clock Battery Slot .....  pg. 8
- ㊱ Tripod Mounting Socket .....  pg. 13







**A**

- AC Power Adapter/Charger .....  pg. 6, 7
- Animation Recording .....  pg. 35, 43
- Audio Dubbing .....  pg. 49
- Auto Date Record .....  pg. 24
- Auto Focus .....  pg. 30
- Auto Shut off .....  pg. 15, 36









**B**

- Battery Pack .....  pg. 6, 7, 57
- Brighten The LCD Monitor .....  pg. 17

**C**

- Car Battery .....  pg. 7
- Charge Marker .....  pg. 7
- Charge The Battery Pack .....  pg. 6
- Clean The Camcorder .....  pg. 50
- Clock (Lithium) Battery .....  pg. 8
- Connections .....  pg. 7, 40

**D**

- Darken The LCD Monitor .....  pg. 17
- Date/Time Display .....  pg. 24
- Date/Time Settings .....  pg. 9
- Demonstration Mode .....  pg. 28
- Digital Zoom .....  pg. 27
- Discharge The Battery Pack .....  pg. 6
- Dioptrre Adjustment .....  pg. 12
- Dubbing .....  pg. 41



**E**

- Electronic Fog Filter Mode .....  pg. 23
- Erase Protection .....  pg. 11
- Exposure Control .....  pg. 29

**F**

- Fade-In/Out .....  pg. 21
- Fast-Forward Tape .....  pg. 36

**G**

- Gain .....  pg. 27
- Grip Adjustment .....  pg. 12

**H**

- High Speed Shutter Mode .....  pg. 23

**I**

- Insert Editing .....  pg. 48
- Instant Titles .....  pg. 25
- Interface Shooting .....  pg. 17



**J**

- Journalistic Shooting .....  pg. 17



**L**

- LCD Monitor/Viewfinder Indication .....  pg. 53
- Load A Tape .....  pg. 11

**M**

- Manual Focus .....  pg. 31
- Menu Screen .....  pg. 27, 28

**N**

- ND Effect Mode .....  pg. 23
- Nega/Posi Mode .....  pg. 23





**P**

- Picture Stabilizer .....  pg. 20
- Power Switch Position .....  pg. 14
- Programme AE With Special Effects .....  pg. 22
- Provided Accessories .....  pg. 3

**Q**

- Quick Review .....  pg. 19









**R**

- Record-Standby .....  pg. 14
- Recording Mode .....  pg. 10
- Remote Control .....  pg. 42
- Retake .....  pg. 19
- Rewind The Tape .....  pg. 36

**S**

- Self-Timer .....  pg. 34, 43
- Sepia .....  pg. 23
- Shoulder Strap Attachment .....  pg. 13
- Shuttle Search .....  pg. 38
- Specifications .....  pg. 59
- Still Playback .....  pg. 38

**T**

- Tally .....  pg. 28
- Tape Counter .....  pg. 36
- Tape Length Setting .....  pg. 10
- Tele Macro .....  pg. 27
- Time-Lapse Shooting .....  pg. 35, 43
- Tracking .....  pg. 37
- Tripod Mounting .....  pg. 13
- Twilight .....  pg. 23

**U**

- Unload A Tape .....  pg. 11

**W**

- White Balance .....  pg. 32, 33
- Wide Mode .....  pg. 27
- Wipe In/Out .....  pg. 21

**Z**

- Zooming .....  pg. 18



## Battery Packs

The battery packs are nickel-cadmium or nickel metal-hydride batteries. Before using the supplied battery pack or an optional battery pack, be sure to read the following cautions:

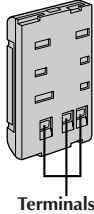

### 1. To avoid hazard . . .

- ... do not burn.
- ... do not short-circuit the terminals.
- ... do not modify or disassemble.
- ... use only specified chargers.

### 2. To prevent damage and prolong service life . . .

- ... do not subject to unnecessary shock.
- ... avoid repeated charging without fully discharging.
- ... charge in an environment where temperatures are within the tolerances shown in the chart below. This is a chemical reaction type battery—cooler temperatures impede chemical reaction, while warmer temperatures can prevent complete charging.
- ... store in a cool, dry place. Extended exposure to high temperatures will increase natural discharge and shorten service life.
- ... avoid prolonged uncharged storage.
- ... remove from charger or powered unit when not in use, as some machines use current even when switched off.

## NOTES:

- *It is normal for the battery pack to be warm after charging, or after use.*
- Temperature Range Specifications**
- Charging ..... 10°C to 35°C
- Operation ..... 0°C to 40°C
- Storage ..... -10°C to 30°C
- *Recharging time is based on room temperature of 20°C.*
- *The lower the temperature, the longer recharging takes.*

## Cassettes

To properly use and store your cassettes, be sure to read the following cautions:

### 1. During use . . .

- ... make sure the cassette bears the VHS-C mark.
- ... be aware that recording onto prerecorded tapes automatically erases the previously recorded video and audio signals.
- ... make sure the cassette is positioned properly when inserting.
- ... do not load and unload the cassette repeatedly without allowing the tape to run at all. This slackens the tape and can result in damage.
- ... do not open the front tape cover. This exposes the tape to fingerprints and dust.

### 2. Store cassettes . . .

- ... away from heaters or other heat sources.
- ... out of direct sunlight.
- ... where they won't be subject to unnecessary shock or vibration.
- ... where they won't be exposed to strong magnetic fields (such as those generated by motors, transformers or magnets).
- ... vertically, in their original cases.

## Main Unit

### 1. For safety, DO NOT . . .

- ... open the camcorder's chassis.
- ... disassemble or modify the unit.
- ... short-circuit the terminals of the battery pack. Keep it away from metallic objects when not in use.
- ... allow inflammables, water or metallic objects to enter the unit.
- ... remove the battery pack or disconnect the power supply while the power is on.
- ... leave the battery pack attached when the camcorder is not in use.

### 2. Avoid using the unit . . .

- ... in places subject to excessive humidity or dust.
- ... in places subject to soot or steam such as near a cooking stove.
- ... in places subject to excessive shock or vibration.
- ... near a television set.
- ... near appliances generating strong magnetic or electric fields (speakers, broadcasting antennas, etc.).
- ... in places subject to extremely high (over 40°C) or extremely low (under 0°C) temperatures.

**3. DO NOT leave the unit . . .**

- ... in places of over 50°C.
- ... in places where humidity is extremely low (below 35%) or extremely high (above 80%).
- ... in direct sunlight.
- ... in a closed car in summer.
- ... near a heater.

**4. To protect the unit, DO NOT . . .**

- ... allow it to become wet.
- ... drop the unit or strike it against hard objects.
- ... subject it to shock or excessive vibration during transportation.
- ... keep the lens directed at extremely bright objects for long periods.
- ... direct the eyepiece of the viewfinder at the sun.
- ... carry it by holding the viewfinder or the LCD monitor. Be sure to hold the main unit with both hands or use the grip.
- ... swing it excessively when using the shoulder strap.

**LCD Monitor****1. To prevent damage to the LCD monitor, DO NOT . . .**

- ... push it strongly or apply any shocks.
- ... place the camcorder with the LCD monitor on the bottom.

**2. To prolong service life . . .**

- ... avoid rubbing it with coarse cloth.

**3. Be aware of the following phenomena for LCD monitor use. These are not malfunctions . . .**

- While using the camcorder, the surface around the LCD monitor and/or the back of the LCD monitor may heat up.
- If you leave power on for a long time, the surface around the LCD monitor becomes hot.

**About moisture condensation . . .**

- You may have observed that pouring a cold liquid into a glass will cause drops of water to form on the glass' outer surface. This same phenomenon occurs on the head drum of a camcorder when it is moved from a cool place to a warm place, after heating a cold room, under extremely humid conditions or in a place directly subjected to the cool air from an air conditioner.
- Moisture on the head drum can cause severe damage to the video tape, and can lead to internal damage to the camcorder itself.

**Serious malfunctioning**

If malfunctioning occurs, stop using the unit immediately and consult your local JVC dealer.

**Special Notes On Video Heads****Dust and dirt on video heads**

1. Always allow enough time for your camcorder to acclimatize to its environment before using it.
2. Do not use the unit in areas of high humidity. (Typical areas of high humidity are given below.)
  - From being used or stored in a very cold outdoor situation, then immediately being used in a warm indoor situation.
  - From being used or stored in a cool air-conditioned situation, then being used in a high-humidity outdoor situation.
  - Other areas where rapid large temperature changes can occur.
3. Taking care of your "C" format video cassette tapes.
  - Store the video cassette tapes in a vertical position, complete in their cassette cases.
  - During transportation, always store cassettes in their cassette cases.
4. Check recorded information at regular intervals. If the camcorder is equipped with a quick review facility, use this facility to check whether the picture is clear or not.
 

If the quick review or playback picture is not clear, then the video heads may be dirty.

**Note:**

As a maladjusted tracking control can give similar symptoms to dirty video heads, please check that the tracking control of the unit is in the centre position.

**Cleaning the video heads**

Accumulation of dirt and other particles on the video heads may cause the playback picture to become blurred or interrupted. Although this camcorder is equipped with a built-in head cleaner which automatically cleans the heads, reducing the likelihood of dirty heads, if such troubles are encountered, we recommend the use of the cleaning cassette specifically designed for JVC camcorders, model number TCC-2U. Please use the cleaning cassette as indicated below:



- ① After inserting the cleaning cassette, activate the Play mode for a maximum of 15 seconds (normally, 5 seconds is sufficient).
- ② Remove the cleaning cassette and check the playback picture with a previously good-recorded tape.
- ③ If the picture is clear, then recording on a new tape can begin when desired.
- ④ If the picture is not clear, repeat steps 1 to 3 up to two more times.
- ⑤ If the picture is still unclear, consult your local JVC dealer.

**Important Note:**

- If heads have become dirty, the associated tape will also be damaged, please do not use the tape again.
- A built-in head cleaner automatically cleans the video heads and head drum whenever a cassette is loaded and unloaded to reduce head clogging.
  - Cleaning cassette TCC-2U is available from your JVC local dealer.

## Camcorder



### General

<b>Format</b>	: VHS PAL standard	<b>Operating temperature</b>	: 0°C to 40°C
<b>Power source</b>	: DC 6.0 V 	<b>Operating humidity</b>	: 35% to 80%
<b>Power consumption</b>		<b>Storage temperature</b>	: -20°C to 50°C
<b>LCD monitor off, viewfinder on</b>	: 5.7 W	<b>Weight</b>	: Approx. 880 g
<b>LCD monitor on, viewfinder off</b>	: 6.2 W	<b>Dimensions (W x H x D)</b>	: 198 mm x 119 mm x 99 mm (with the LCD monitor closed and with the viewfinder fully tilted downward)
<b>LCD monitor on, viewfinder on</b>	: 6.8 W	<b>Pickup</b>	: 1/4" format CCD
<b>Signal system</b>	: PAL-type	<b>Lens</b>	: F1.6, f = 3.9 to 62.4 mm, 16:1 power zoom lens with auto iris and macro control, filter diameter 40.5 mm
<b>Video recording system</b>		<b>Viewfinder</b>	: Electronic viewfinder with 0.5" black/white CRT
<b>Luminance</b>	: FM recording	<b>White balance adjustment</b>	: Auto/Manual adjustment
<b>Colour</b>	: Converted sub-carrier direct recording Conforms to VHS standard	<b>LCD monitor</b>	: 2.5" diagonally measured, LCD panel/TFT active matrix
<b>Cassette</b>	:  cassette	<b>Speaker</b>	: Monaural
<b>Tape speed</b>			
<b>SP</b>	: 23.39 mm/sec.		
<b>LP</b>	: 11.70 mm/sec.		
<b>Recording time (max.)</b>			
<b>SP</b>	: 60 minutes		
<b>LP</b>	: 120 minutes (with EC-60 cassette)		

### Connectors

<b>JLIP</b>	: ø3.5 mm, 4-pole, mini-head jack (compatible with RC-5325 plug)	<b>Video</b>	: 1 V(p-p), 75 Ω unbalanced, analogue output (via Video output connector)
		<b>Audio</b>	: 300 mV (rms), 1 kΩ analogue output (via Audio output connector)

### AC Power Adapter/Charger AA-V16EK

<b>Power requirement</b>	: AC 110 V to 240 V~, 50 Hz/60 Hz
<b>Power consumption</b>	: 23 W
<b>Output</b>	
<b>Charge</b>	: DC 8.5 V  , 1.3 A
<b>VTR</b>	: DC 6.3 V  , 1.8 A
<b>Charging system</b>	: Constant current, peak detection, timer controlled
<b>Dimensions (W x H x D)</b>	: 125 mm x 42 mm x 68 mm
<b>Weight</b>	: Approx. 330 g

### Optional Accessories

- Battery Packs BN-V12U, BN-V20U, BN-V856U
- Car Battery Charger BH-V3E
- Compact VHS () Cassettes EC-60/45/30
- Remote Control Unit RM-V700U
- Active Carrying Bag CB-V7U
- Cassette Adapter C-P7U

Some accessories are not available in some areas. Please consult your nearest JVC dealer for details on accessories and their availability.

*Specifications shown are for SP mode unless otherwise indicated.*

*E & O.E. Design and specifications subject to change without notice.*

